



LUKER ELECTRIC TECHNOLOGIES PVT. LTD.

Regd. Office: 34/1912-C1, Mattathil Lane, BTS Road, Kochi-682024, Ernakulam, KERALA
 Corp. Office: 2nd Floor, Jain Tower, NH- 17 Bypass, Opp. Lulu Mall, Edappally, Kochi - 682 024, Ph: +91 9746497564, +91 9895418525, +91 9895011400
 Email : sales@lukerindia.com, Factory : 54, Krishnarayapuram Thollasalai, Old Cochin Bypass Road, Chettipalayam, Coimbatore - 641201, Tamilnadu, India,
 Tamilnadu: Coimbatore: No 22, First Floor, RV Centre, ATT Colony, Park Gate Road, Coimbatore - 641018.+91 9894090819, 8870810999, Chennai: No.11/6, Damodaran
 Street, Chetpet, Chennai- 600031, Ph: +91 93440 77555, 9944406353, New Delhi : Ground Floor, KH No : 53/11/1, Fimi Road, Village Mundaka, Pole No. MDKUG71,
 New Delhi - 110041, Ph: 8510981234, Karnataka : # 1583, 13th Main, 20th Cross, B-Block, Sahakar Nagar, Bangalore-560092, Ph: 9008487009, Hyderabad: Babukhans
 Millennium Centre, Flat No.106, 1st Floor, Somajiguda, Hyderabad, Ph: 040 23416268, 9866077902, Mumbai: 1806, Lodha Supremus, Saki Vihar Road, Opp. M.T.N.L.
 Building, Andheri (East), Mumbai - 400072, Ph: +91 9820009055, +91 9769207676 Kolkata: 4A, Pollock Street, Swaika Centre, 4th Floor, Room No. 408, Kolkata-700001
 Ph : 9163000333

Representative offices at : Warrangal - 7893039571, Karim Nagar - 9652136716, Kakinada - 9000554811, Mangalore - 7022119165, Salem - 9994422007/ 9994013192,
 Thirunelveli - 9994493242, Madurai - 9894090819, Trichy - 8056180666, Vellore - 90430 99737, Pondicherry - 9940445149, 9944406353, Pune - 9890696933, Nagpur - 9850395269,
 Nasik - 7769091911, Baroda - 9687300643, Raipur - 9399613842, 9827216350, Bhopal - 9300082600, Kolkata - 9831184486, Vijayawada - 8019969551, Visakhapatnam - 9246999368,
 Guntur - 8019969551, Goa - 9158159062, Indore - 9329754005, Ahmedabad - 9687300643, Surat - 9825506072, Rajkot - 9687300643, Jabalpur - 9407154296, Gwalior - 9329754005,
 Eluru - 9000326440, Rajahmundry - 9000554811, Tirupati - 9866965656, Khammam - 9160018382, Nizamabad - 9703780070, Patna - 7762995833, Siliguri - 7430020990

Luker Electric Technologies Inc.

1 Cragwood RD STE 103A, S Plainfield, NJ 07080, U S A, Ph: +1 (914) 573-1616, www.lukerus.com

Luker Inc.
Dean Park Road,
Scarpoorough,
Toronto, Canada

Luker Inc.
25, Bon Church Road
ELM Grove
Brighton, United Kingdom

Luker Electric Technologies
9, Ivy Court
Cranbourne North
Victoria 3977, Melbourne

Luker Electric Tech. LLC
173, Road 1111/311
Manama, P.O. Box 1049
Kingdom of Bahrain

LED THE COMPLETE
LIGHTING SOLUTION

**PRODUCTS
CATALOGUE**



India needs a strong industrial base that is the product of a huge amount of resources and technology. It is necessary to find out alternatives for optimum utilization of available energy.

Luker Electric Technologies PVT Ltd is a joint venture with Luker USA that has made it gain popularity as the best lighting company in the world. The significant investment in developing new technologies has led the global lighting revolution with the likes of advanced fixtures and lighting solutions.

Being a superior lighting consultant, Luker has a potential of more than 20,000 crores and rapidly growing. The support of central and state governments has enabled the market to grow by leaps and bounds. Named the best lighting company, Luker offers lighting products like bulbs and tubes. With a wide range of LED lighting adhering to international quality, Luker is considered among the topmost brands in India.

Discovering the challenges that the industry is facing, the research and development team has come up with innovations to build Luker as a prominent lighting consultant all over the world. Luker comes with extensive variety, shape, and design, use of colors, energy-saving, etc. It provides consistency in quality and business ethics to the customers and its standards are leading edge.

With the flexibility and adaptability that Luker is promising, it brings the best range of products. The fast pace that the technology is evolving helps ensure it is the best and the future is bright.

Our Business

Luker has developed and manufactured LED lights of the next-gen that meet local and international standards. It is undoubtedly the best lighting company integrating advanced thermal management, short circuit and open circuit protection including other innovative features. Added to this, the products undergo rigorous testing before it leaves the factories.

The history, experience, and approach to engineering and manufacturing of LEDs ensure that Luker is rated the best and the products stand out from the rest with high quality.

A Brighter Future Ahead

Luker is being led by clever design and innovative thinking that fuels the drive for being the best lighting company with efficient and premium LED lighting products. It is a product of detailed product design with the help of mechanical engineers to industrial designers and software engineers including experienced electronics engineers for constantly developing the technology.



VISION

At Luker, we are coming together to make the world healthier and more sustainable through innovation. We aim to improve the lives of billions of people. The global reach, deep insights and leading innovations from Luker have positioned us as the makers of the best-LED lights worldwide.



MISSION

Our products deliver the following to the worldwide community:

- Connected products that work for the well being of people
- Integrating informatics with the latest technology
- Real-time guidance devices that are smart to use

While branded LEDs rule the show, they help people make use of energy-efficient options in place of traditional applications of energy.

Luker teams up with industry experts to produce the likes of emergency bulbs so that they provide integrated solutions in lighting designs.



LUKER, J.V. Luker USA has built one of the largest LED manufacturing plant in Asia under "MAKE IN INDIA" concept to promote energy saving products in India.

The manufacturing facility is spread over 21 acres of land with more than 2,65,000 Sq. ft. of built-up area in the Green City of South India, Coimbatore.



CERTIFICATIONS



CONTENTS

<i>LED Bulbs</i>	1-6
<i>LED Tube Lights</i>	7-14
<i>IRIS LED Slim panel lights</i>	15-17
<i>LED Cleanroom & Dimmable Panel Lights</i>	18
<i>DURO NEO Led slim panel</i>	19-20
<i>IRIS Led surface panel</i>	21-22
<i>LISO Led trimless surface panels</i>	23-26
<i>LIVIANO LED Slim Panel Lights</i>	27-28
<i>LED Down Lights</i>	29-34
<i>CORVUS LED COB Downlights</i>	35-45
<i>FREMO Focus led light</i>	46-47
<i>FISSO Zoom led light</i>	48
<i>FUOCO Track led lights</i>	49-52
<i>LED Strip indoor</i>	53-56
<i>AMPIO Strip drivers</i>	57-58

CONTENTS

<i>RICO Sleek ceiling led</i>	59
<i>STRADA Led street lights</i>	60-62
<i>LED Flood lights</i>	63-67
<i>LED Tunnel lights</i>	68
<i>Well glass & canopy Lights</i>	69-70
<i>Wall washer led lights</i>	71
<i>Highbay Lights</i>	72-75
<i>Linear led lighting</i>	76-80
<i>LUSSO Led linear lighting</i>	81-82
<i>ALCUNO Led strip & Accesories</i>	83-84
<i>EMERGENCY Lights</i>	85
<i>VICINO Smart backlit panel</i>	86
<i>SOLTERO Solar street light</i>	87-88



FOCO HIGH GLOW BULBS



FOCO HIGH GLOW BULBS



Product Code	Wattage	Voltage	Power Factor	System Luminous Efficacy	CRI	LED Light Source	Beam Angle	CCT	IP Rating	Surge Voltage	Base
LBCOL05	0.5W	230V	>0.95	80 LM/W	>80	SMD	120°	WH,BL GR,YL,RD,PK	IP20	2 KV	B22
LBPC03CL	3W	230V	>0.95	110 LM/W 95 LM/W	>80	SMD	120°	WH WW	IP20	3 KV	B22/E27
LBPC05CL	5W	230V	>0.95	110 LM/W	>80	SMD	120°	WH	IP20	3 KV	B22/E27
LBPCE05	5W	230V	>0.95	95 LM/W	>80	SMD	120°	WW	IP20	3 KV	B22/E27
LBPC07CL	7W	230V	>0.95	110 LM/W	>80	SMD	120°	WH	IP20	3 KV	B22/E27
LBPCE07	7W	230V	>0.95	95 LM/W	>80	SMD	120°	WW	IP20	3 KV	B22/E27
LBPC09CL	9W	230V	>0.95	110 LM/W	>80	SMD	120°	WH	IP20	3 KV	B22/E27
LBPCE09	9W	230V	>0.95	95 LM/W	>80	SMD	120°	WW	IP20	3 KV	B22/E27
LBPC12CL	12W	230V	>0.95	110 LM/W	>80	SMD	120°	WH	IP20	3 KV	B22/E27
LBPCE12	12W	230V	>0.95	95 LM/W	>80	SMD	120°	WW	IP20	3 KV	B22/E27
LBPC15CL	15W	230V	>0.95	110 LM/W	>80	SMD	120°	WH	IP20	3 KV	B22/E27
LBPCE15	15W	230V	>0.95	95 LM/W	>80	SMD	120°	WW	IP20	3 KV	B22/E27
LBPC18CL	18W	230V	>0.95	110 LM/W	>80	SMD	120°	WH	IP20	3 KV	B22/E27
LBPCE18	18W	230V	>0.95	95 LM/W	>80	SMD	120°	WW	IP20	3 KV	B22/E27
LBPC26	26W	230V	>0.95	100 LM/W	>80	SMD	120°	WH WW	IP20	3 KV	B22/E27

Dimension (in mm)

WATTAGE	DIA	HEIGHT
0.5W	69	45
3W	50	90
5W	60	112
7W	60	112
9W	60	112
12W	60	117
15W	70	132
18W	80	144
26W	95.3	183.3

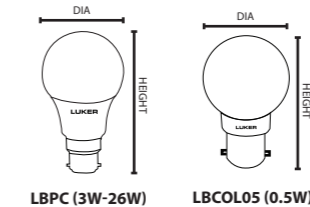

Product Features

Rated Life : 30000 Hrs
 Mounting Type : B22/E27 Holder
 Housing & Finish : PBT with Aluminium Heat Sink + PC Diffuser

Applications

Houses, Hotels, Restaurants, Warehouse



FOCO HIGH GLOW BULBS

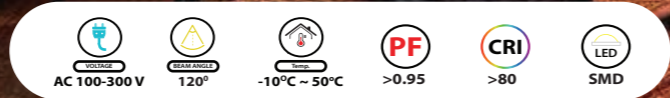

STELLO HIGH GLOW BULBS



Product Code	Wattage	Voltage	Power Factor	System Luminous Efficacy	CRI	LED Light Source	Beam Angle	CCT	IP Rating	Surge Voltage	Base
LBPC30	30W	230V	>0.95	100 LM/W	>80	SMD	120°	WH WW	IP20	3 KV	B22/E27
LBPC36N	36W	230V	>0.95	100 LM/W	>80	SMD	120°	WH WW	IP20	3 KV	B22/E27
LBPC40N	40W	230V	>0.95	100 LM/W	>80	SMD	120°	WH WW	IP20	3 KV	B22/E27
LBPC48N	48W	230V	>0.95	100 LM/W	>80	SMD	120°	WH WW	IP20	3 KV	B22/E27
LBPC50N	50W	230V	>0.95	100 LM/W	>80	SMD	120°	WH WW	IP20	3 KV	B22/E27

Dimension (in mm)

WATTAGE	DIA	HEIGHT
30W	96	157
36W	111	203
40W	200	118
48W	136	226
50W	135	233

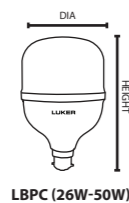

LBPC (26W-50W)

Product Features

- Holder Type : B22/E27
- Rated Life : 30000 Hrs
- Mounting Type : B22/E27 Holder
- Housing & Finish : PBT with Aluminium Heat Sink + PC Diffuser

Applications

Houses, Hotels, Restaurants, Warehouse



Product Code	Wattage	Voltage	Power Factor	System Luminous Efficacy	CRI	LED Light Source	Beam Angle	CCT	IP Rating	Surge Voltage	Base
LBPC12ST	12W	230V	>0.95	110 LM/W	>80	SMD	120°	WH	IP20	3 KV	B22/E27
LBPC15ST	15W	230V	>0.95	110 LM/W	>80	SMD	120°	WH	IP20	3 KV	B22/E27
LBPC18ST	18W	230V	>0.95	110 LM/W	>80	SMD	120°	WH	IP20	3 KV	B22/E27

Dimension (in mm)

WATTAGE	DIA	HEIGHT
12W	63.6	124.4
15W	64.2	125.2
18W	72	144.2



Product Features

- Holder Type : B22/E27
- Rated Life : 30000 Hrs
- Mounting Type : B22/E27 Holder
- Housing & Finish : PBT with Aluminium Heat Sink + PC Diffuser

Applications

Houses, Hotels, Restaurants, Warehouse



GIALLO CANDLE BULB



GIALLO FILAMENT BULB

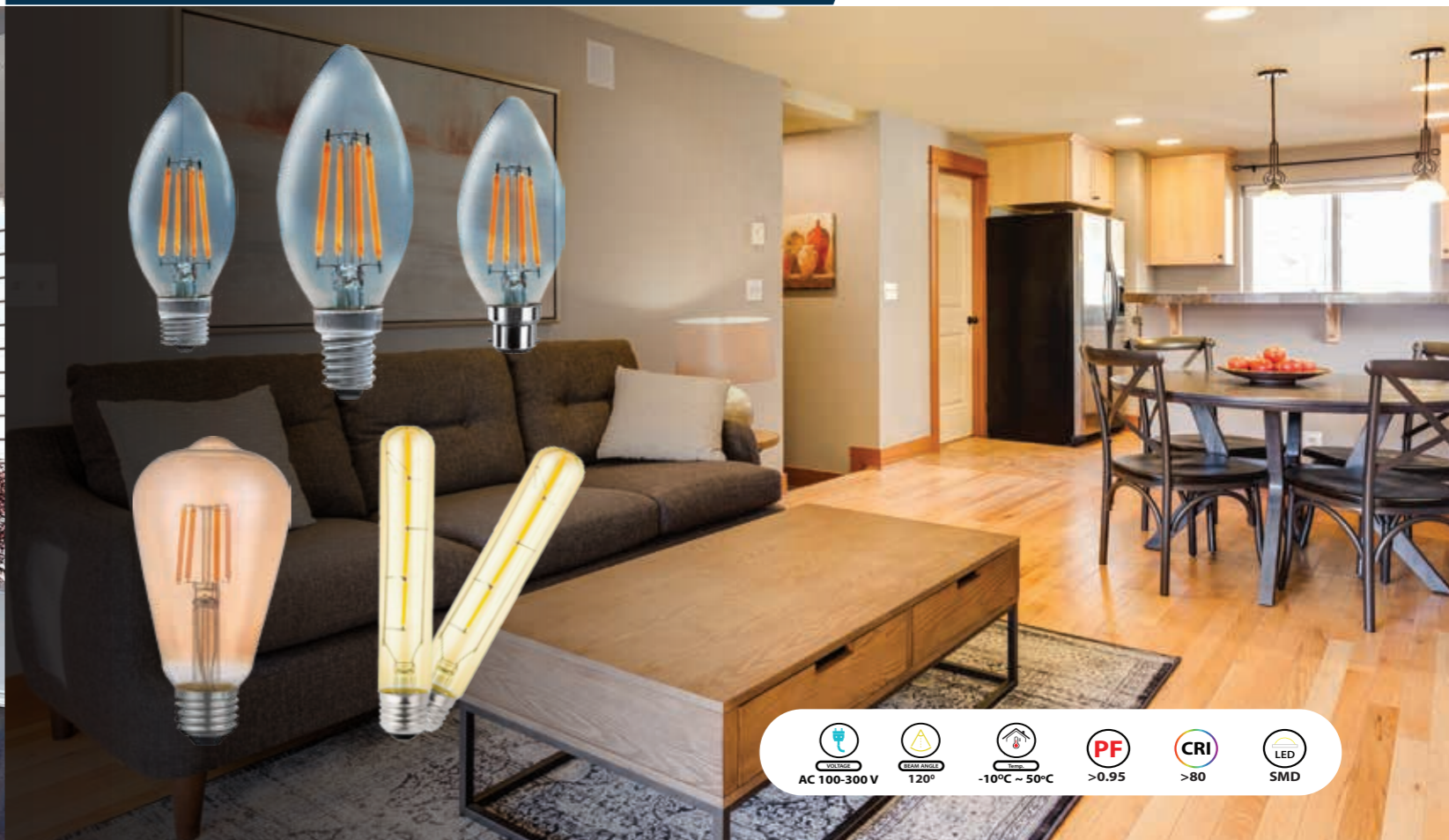

Product Code	Wattage	Voltage	Power Factor	System Luminous Efficacy	CRI	LED Light Source	Beam Angle	CCT	IP Rating	Surge Voltage	Base
LBGC03	3W	230V	>0.95	100 LM/W	>80	SMD	120°	WH WW	IP20	2 KV	B22/E27 /E14
LBGC05	5W	230V	>0.95	100 LM/W	>80	SMD	120°	WH WW	IP20	2 KV	B22/E27 /E14

Dimension (in mm)

WATTAGE	DIA	HEIGHT
3W	36	98.9
5W	36	98.9

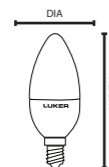

Product Features

Rated Life : 30000 Hrs
 Mounting Type : B22/E27/E14 Holder
 Housing & Finish : PBT with Aluminium Heat Sink + PC Diffuser

Applications

Houses, Hotels, Restaurants, Warehouse



Product Code	Wattage	Voltage	Power Factor	System Luminous Efficacy	CRI	LED Light Source	Beam Angle	CCT	IP Rating	Surge Voltage	Base
LBFB2204											B22
LBFE2704	4W	230V	>0.95	100 LM/W	>80	SMD	180°	WH, WW	IP20	2 KV	E27
LBFE1404											E14
LBFE2704 AM ST64	4W	230V	>0.95	100 LM/W	>80	SMD	180°	WW(2000K)	IP20	2 KV	E27
LBFE2704 AM T225	4W	230V	>0.95	100 LM/W	>80	SMD	180°	WW(2000K)	IP20	2 KV	E27

Dimension (in mm)

PRODUCT CODE	DIA	HEIGHT
LBFB2204 LBFE2704 LBFE1404	35	90
LBFE2704 AM ST64	64.3	143
LBFE2704 AM T225	28	219.5

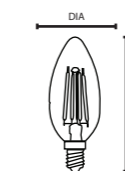

LBFB2204 (4W)

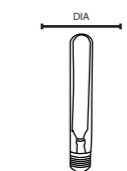

LBFE2704 AM ST64 (4W)

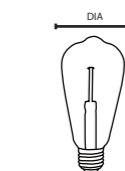

LBFE2704 AM T225(4W)

Product Features

Rated Life : 30000 Hrs
 Mounting Type : B22/E27/E14 Holder
 Housing & Finish : Glass body & Clear diffuser

Applications

Houses, Hotels, Restaurants, Warehouse





LUMOS LED TUBE LIGHTS

LUMOS ECCO PC TUBES



Product Code	Wattage	Voltage	Power Factor	System Luminous Efficacy	CRI	LED Light Source	Beam Angle	CCT	IP Rating	Surge Voltage	THD
LT505P	5W	230V	>0.95	100 LM/W	>80	SMD	120°	WH,WW	IP20	3 KV	<15%
LT510P	10W	230V	>0.95	100 LM/W	>80	SMD	120°	WH,WW	IP20	3 KV	<15%
LT520P	20W	230V	>0.95	100 LM/W	>80	SMD	120°	WH,WW NW	IP20	3 KV	<15%
LT524P	24W	230V	>0.95	100 LM/W	>80	SMD	120°	WH,WW	IP20	3 KV	<15%
LT-26W	26W	230V	>0.95	100 LM/W	>80	SMD	120°	WH	IP20	3 KV	<15%
LT36W	36W	230V	>0.95	100 LM/W	>80	SMD	120°	WH,WW	IP20	3 KV	<15%
LT52W	52W	230V	>0.95	100 LM/W	>80	SMD	120°	WH	IP20	3 KV	<15%

Dimension (in mm)

PRODUCT CODE	LENGTH	WIDTH	HEIGHT
LT505P	288	20.4	31.6
LT510P	570	20	33
LT520P	1180	21	35.7
LT524P	1180	21.8	36.8
LT-26W	1180	21.8	36.8
LT36W	1190	31	43
LT52W	1198	43.5	31

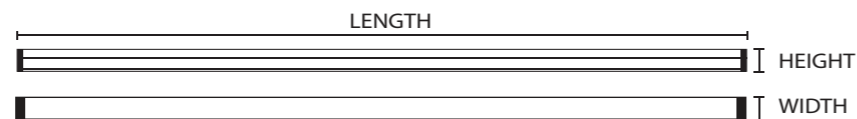

Product Features

Rated Life : 30000 Hrs
 Mounting Type : Surface Mounted
 Housing & Finish : Poly Carbonate Body + PC Diffuser

Applications

Houses, Offices, Hospitals, Showrooms

LUMOS PRIMO ALUMINIUM TUBES

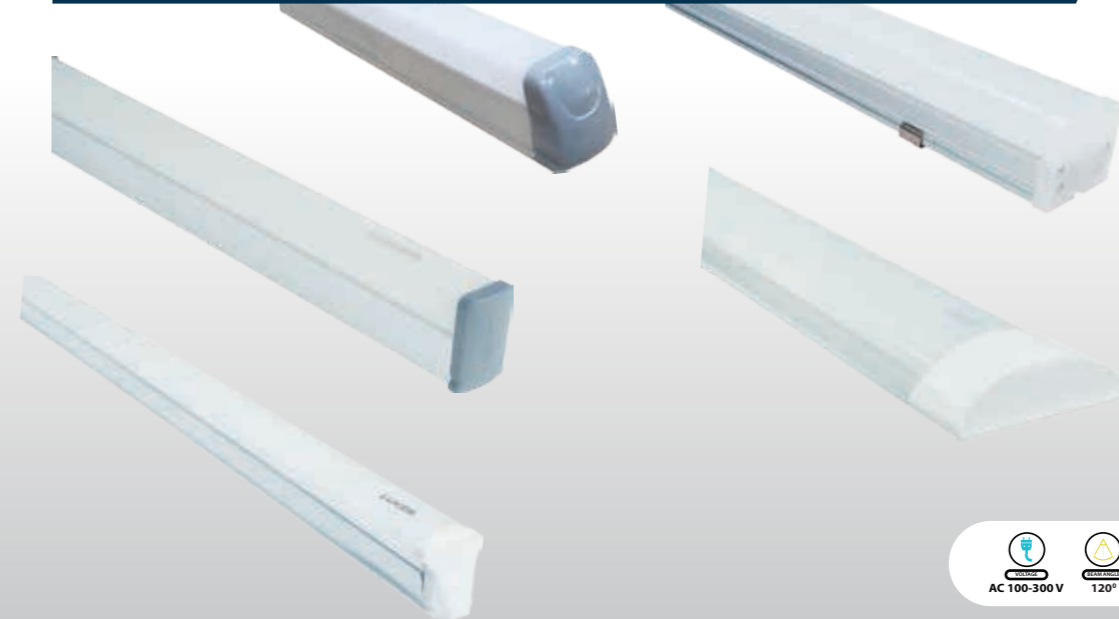

Product Code	Wattage	Voltage	Power Factor	System Luminous Efficacy	CRI	LED Light Source	Beam Angle	CCT	IP Rating	Surge Voltage	THD
LT520	20W	230V	>0.95	100 LM/W	>80	SMD	120°	WH,WW NW	IP20	3 KV	<15%
LT522	22W	230V	>0.95	100 LM/W	>80	SMD	120°	WH,WW NW	IP20	3 KV	<15%
LT5M20	20W	230V	>0.95	100 LM/W	>80	SMD	120°	WH,WW	IP20	3 KV	<15%
LT5M24	24W	230V	>0.95	100 LM/W	>80	SMD	120°	WH	IP20	3 KV	<15%
LT832	32W	230V	>0.95	100 LM/W	>80	SMD	120°	WH	IP20	3 KV	<15%
LTH36	36W	230V	>0.95	100 LM/W	>80	SMD	120°	WH,WW	IP20	3 KV	<15%
LTH40	40W	230V	>0.95	100 LM/W	>80	SMD	120°	WH,WW	IP20	3 KV	<15%

Dimension (in mm)

PRODUCT CODE	LENGTH	WIDTH	HEIGHT
LT520	1180	20	31.8
LT522	1180	20	31.8
LT5M20	1200	21.4	36.9
LT5M24	1200	21.4	36.9
LT832	1208	29	37
LTH36	1205	72.9	23.8
LTH40	1190	50.7	44.2

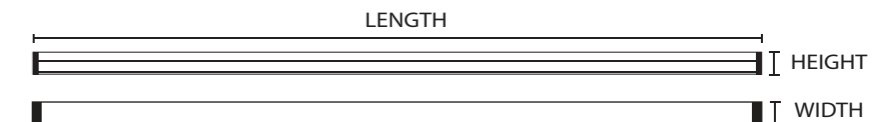

Product Features

Rated Life : 30000 Hrs
 Mounting Type : Surface Mounted
 Housing & Finish : Aluminium + PC Diffuser

Applications

Houses, Offices, Hospitals, Showrooms

LUMOS OUTDOOR TUBE SET

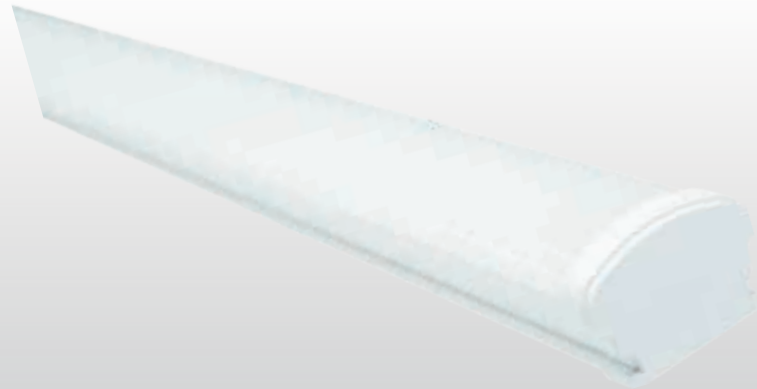

Product Code	Wattage	Voltage	Power Factor	System Luminous Efficacy	CRI	LED Light Source	Beam Angle	CCT	IP Rating	Surge Voltage	THD
LTOD40	36W	230V	>0.95	100 LM/W	>80	SMD	120°	WH,WW	IP65	3 KV	<15%

Dimension (in mm)

PRODUCT CODE	LENGTH	WIDTH	HEIGHT
LTOD40	1200	49	46.7

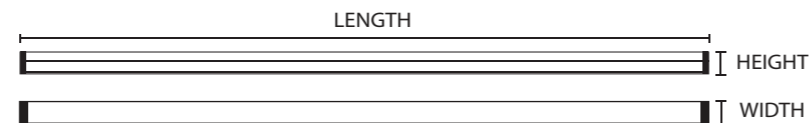

Product Features

Rated Life : 30000 Hrs
 Mounting Type : Surface Mounted
 Housing & Finish : ABS Plastic Body + PC Diffuser

Applications

Cold Storage, Hatchery, Industries, Warehouse



LUMOS SENZA SENSOR TUBE SET

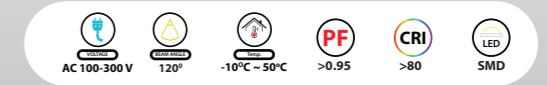

Product Code	Wattage	Voltage	Power Factor	System Luminous Efficacy	CRI	LED Light Source	Beam Angle	CCT	IP Rating	Surge Voltage	THD
LT809SR	9W	230V	>0.95	100 LM/W	>80	SMD	120°	WH,WW NW	IP20	3 KV	<15%
LT818SR	18W	230V	>0.95	100 LM/W	>80	SMD	120°	WH,WW NW	IP20	3 KV	<15%
LT818TSR	18W	230V	>0.95	100 LM/W	>80	SMD	120°	WH,WW NW	IP20	3 KV	<15%

Dimension (in mm)

PRODUCT CODE	LENGTH	WIDTH	HEIGHT
LT809SR	573	30	37
LT818SR	1183	30	37

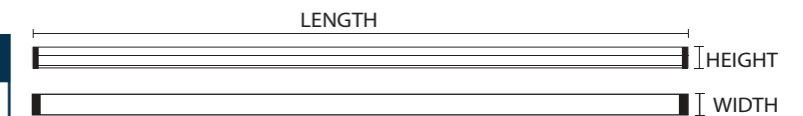

PRODUCT CODE	DIA	L1	L2
LT818TSR	32	1203	1215

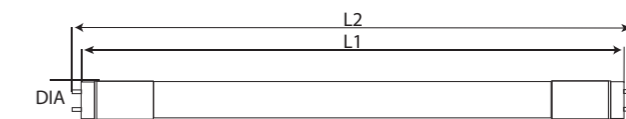

Product Features

Rated Life : 30000 Hrs
 Mounting Type : Surface Mounted
 Housing & Finish : Aluminium + PC Diffuser

Applications

Houses, Offices, Hospitals, Warehouse, Corridor



LUMOS HIGH LUMEN TUBES



Product Code	Wattage	Voltage	Power Factor	System Luminous Efficacy	CRI	LED Light Source	Beam Angle	CCT	IP Rating	Surge Voltage	THD
LT12402	40W	230V	>0.95	100 LM/W	>80	SMD	120°	WH	IP20	3 KV	<15%
LT12402R	40W	230V	>0.95	100 LM/W	>80	SMD	120°	WH	IP20	3 KV	<15%
LT1260	60W	230V	>0.95	100 LM/W	>80	SMD	120°	WH	IP20	3 KV	<15%
LT1260R	60W	230V	>0.95	100 LM/W	>80	SMD	120°	WH	IP20	3 KV	<15%

Dimension (in mm)

PRODUCT CODE	LENGTH	WIDTH	HEIGHT
LT12402	602	49	38
LT12402R	602	95	36
LT1260	1185	48	34
LT1260R	1185	90	40

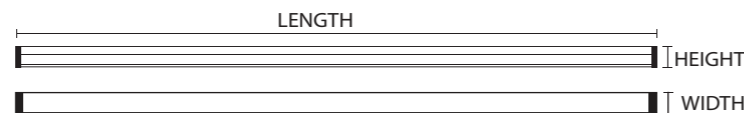

Product Features

- Rated Life : 30000 Hrs
- Mounting Type : Surface Mounted
- Housing & Finish : Poly Carbonate Body + PC Diffuser

Applications

Houses, Offices, Hospitals, Showrooms



LUMOS LED RETROFIT TUBES



Product Code	Wattage	Voltage	Power Factor	System Luminous Efficacy	CRI	LED Light Source	Beam Angle	CCT	IP Rating	Surge Voltage	THD
LT1818T	18W	230V	>0.95	100 LM/W	>80	SMD	120°	WH,WW NW	IP20	3 KV	<15%
LT1818T-5Y	18W	230V	>0.95	100 LM/W	>80	SMD	120°	WH	IP20	3 KV	<15%
LTP818	18W	230V	>0.95	100 LM/W	>80	SMD	120°	WH	IP20	3 KV	<15%
LTP820	20W	230V	>0.95	100 LM/W	>80	SMD	120°	WH	IP20	3 KV	<15%

Dimension (in mm)

PRODUCT CODE	DIA	L1	L2
LT1818T	26.6	1198	1214
LT1818T-5Y	30	1198	1214
LTP818	26	1200	1218
LTP820	26	1200	1218

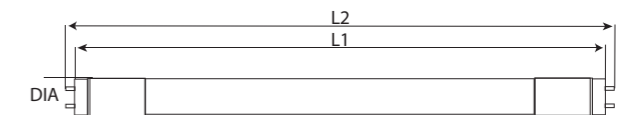

Product Features

- Rated Life : 30000 Hrs
- Mounting Type : G13 Fixture
- Housing & Finish : Aluminium + PC Diffuser

Applications

Houses, Offices, Hospitals, Warehouse, Corridor



STATO LED RETROFIT BATTENS



CASO RETROFIT LUMINAIRES (IP65)



Product Code	Wattage	Voltage	Power Factor	System Luminous Efficacy	CRI	LED Light Source	Beam Angle	CCT	IP Rating	Surge Voltage	THD
LLTS1	1x18W	230V	NA	NA	NA	NA	NA	NA	NA	NA	NA
LLTS2	2x18W	230V	NA	NA	NA	NA	NA	NA	NA	NA	NA
LLTS1N	1x18W	230V	NA	NA	NA	NA	NA	NA	NA	NA	NA

Dimension (in mm)

PRODUCT CODE	LENGTH	WIDTH	HEIGHT
LLTS1	1230	37.6	23
LLTS2	1230	39	22.1
LLTS1N	1235	35.5	30.2

Product Features

Rated Life : 30000 Hrs
 Mounting Type : G13 Fixture
 Housing & Finish : Aluminium + PC Diffuser

Applications

Houses, Offices, Hospitals, Warehouse, Corridor

Product Code	Wattage	Voltage	Power Factor	System Luminous Efficacy	CRI	LED Light Source	Beam Angle	CCT	IP Rating	Surge Voltage	THD
LOC209	2X9W	230V	NA	NA	NA	NA	NA	NA	IP65	NA	NA
LOC218	2X18W	230V	NA	NA	NA	NA	NA	NA	IP65	NA	NA
LOC118	1X18W	230V	NA	NA	NA	NA	NA	NA	IP65	NA	NA

Dimension (in mm)

PRODUCT CODE	LENGTH	WIDTH	HEIGHT
LOC209	655	105	55
LOC218	1267	120	57
LOC118	1260	73	64

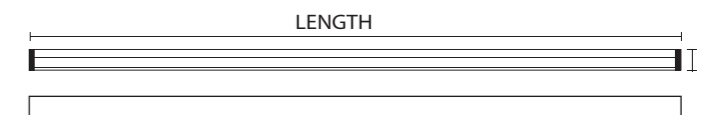

Product Features

Mounting Type : Surface Mounted
 Housing & Finish : Poly Carbonate Body + PC Diffuser

Applications

Domestic, Commercial



**IRIS
LED SLIM PANEL**

IRIS LED SLIM PANEL

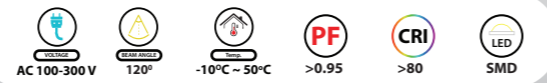

IRIS LED SLIM PANEL

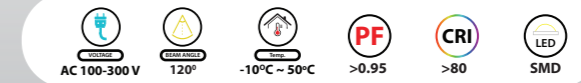
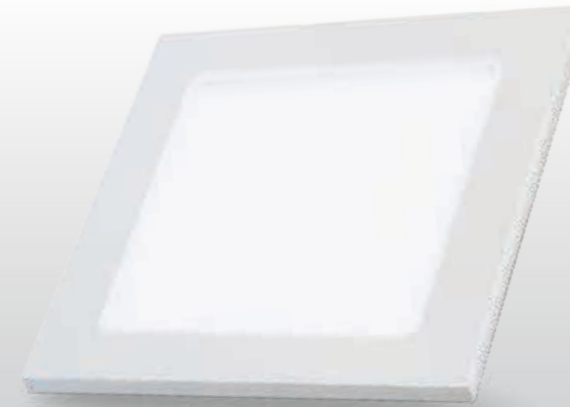

Product Code	Wattage	Voltage	Power Factor	System Luminous Efficacy	CRI	LED Light Source	Beam Angle	CCT	IP Rating	Surge Voltage	THD
LNPR03	3W	230V	>0.95	100 LM/W	>80	SMD	120°	WH,WW NW	IP20	4 KV	<15%
LNPR06*	6W	230V	>0.95	100 LM/W	>80	SMD	120°	WH,WW NW, 3 IN 1	IP20	4 KV	<15%
LNPR09	9W	230V	>0.95	100 LM/W	>80	SMD	120°	WH,WW NW	IP20	4 KV	<15%
LNPR12*	12W	230V	>0.95	100 LM/W	>80	SMD	120°	WH,WW NW, 3 IN 1	IP20	4 KV	<15%
LNPR15	15W	230V	>0.95	100 LM/W	>80	SMD	120°	WH,WW NW	IP20	4 KV	<15%
LNPR18	18W	230V	>0.95	100 LM/W	>80	SMD	120°	WH,WW NW	IP20	4 KV	<15%
LNPR30	30W	230V	>0.95	100 LM/W	>80	SMD	120°	WH,WW NW	IP20	4 KV	<15%

Product Code	Wattage	Voltage	Power Factor	System Luminous Efficacy	CRI	LED Light Source	Beam Angle	CCT	IP Rating	Surge Voltage	THD
LNPS03	3W	230V	>0.95	100 LM/W	>80	SMD	120°	WH,WW NW	IP20	4 KV	<15%
LNPS06*	6W	230V	>0.95	100 LM/W	>80	SMD	120°	WH,WW NW, 3 IN 1	IP20	4 KV	<15%
LNPS09	9W	230V	>0.95	100 LM/W	>80	SMD	120°	WH,WW NW	IP20	4 KV	<15%
LNPS12*	12W	230V	>0.95	100 LM/W	>80	SMD	120°	WH,WW NW, 3 IN 1	IP20	4 KV	<15%
LNPS15	15W	230V	>0.95	100 LM/W	>80	SMD	120°	WH,WW NW	IP20	4 KV	<15%
LNPS18	18W	230V	>0.95	100 LM/W	>80	SMD	120°	WH,WW NW	IP20	4 KV	<15%
LNPS30	30W	230V	>0.95	100 LM/W	>80	SMD	120°	WH,WW NW	IP20	4 KV	<15%

Dimension (in mm)

PRODUCT CODE	DIA	HEIGHT	CUT-OUT
LNPR03	89	16.44	72.8
LNPR06	120	17.22	101.3
LNPR09	144	17.22	124.7
LNPR12	170	17.2	153
LNPR15	170	20.22	152.4
LNPR18	225	20.2	204.7
LNPR30	295	17.2	273

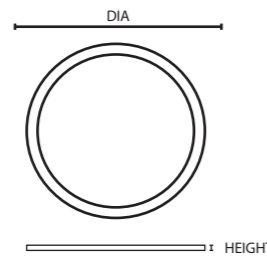

LNPR (3W-30W)

Product Features

- Rated Life : 50000 Hrs
- Mounting Type : Recess Mounted
- Housing & Finish : Die Cast Aluminium + PC Diffuser

Applications

Houses, Offices, Hospitals, Showrooms

*3 in 1 CCT Model available in 6W and 12W



Dimension (in mm)

PRODUCT CODE	LENGTH	WIDTH	HEIGHT	CUT-OUT
LNPS03	90	90	24	73 X 73
LNPS06	119	119	18	102 X 102
LNPS09	145	145	18	124 X 124
LNPS12	170	170	18	152.6 X 152.6
LNPS15	170	170	17.9	152.6 X 152.6
LNPS18	225	225	18.26	203 X 203
LNPS30	298	298	18	172 X 172

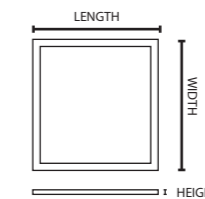

LNPS (3W-30W)

Product Features

- Rated Life : 50000 Hrs
- Mounting Type : Recess Mounted
- Housing & Finish : Die Cast Aluminium + PC Diffuser

Applications

Houses, Offices, Hospitals, Showrooms

*3 in 1 CCT Model available in 6W and 12W



IRIS LED SLIM PANEL

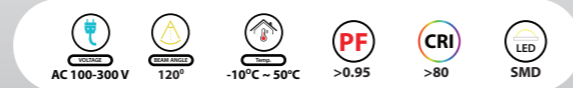

IRIS CLEANROOM & DIMMABLE PANEL

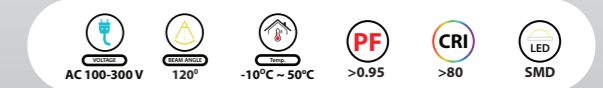

Product Code	Wattage	Voltage	Power Factor	System Luminous Efficacy	CRI	LED Light Source	Beam Angle	CCT	IP Rating	Surge Voltage	THD
LPS40	40W	230V	>0.95	100 LM/W	>80	SMD	120°	WH,WW NW	IP20	4 KV	<15%
LPS48	48W	230V	>0.95	100 LM/W	>80	SMD	120°	WH	IP20	4 KV	<15%
LPS42	40W	230V	>0.95	100 LM/W	>80	SMD	120°	WH	IP20	4 KV	<15%
LPS4812	48W	230V	>0.95	100 LM/W	>80	SMD	120°	WH,WW NW	IP20	4 KV	<15%

Product Code	Wattage	Voltage	Power Factor	System Luminous Efficacy	CRI	LED Light Source	Beam Angle	CCT	IP Rating	Surge Voltage	THD
LPS40IP65	40W	230V	>0.95	100 LM/W	>80	SMD	120°	NW	IP65	4 KV	<15%
LKM2240IP65	40W	230V	>0.95	100 LM/W	>80	SMD	120°	WH	IP65	4 KV	<15%
LPSD40*	40W	230V	>0.95	100 LM/W	>80	SMD	120°	WH,WW NW	IP20	4 KV	<15%

*ANALOG (0-10V) DIMMABLE SLIMPANEL

Dimension (in mm)

PRODUCT CODE	LENGTH	WIDTH	HEIGHT	CUT-OUT
LPS40	596	596	9.8	570 X 570
LPS48	595	595	9	570 X 570
LPS42	1195	150	8	1170 X 140
LPS4812	1195	295	8	1170 X 270

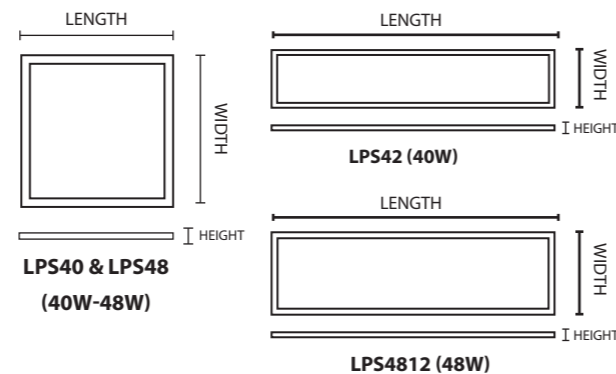

Product Features

Rated Life : 50000 Hrs
 Mounting Type : Recess Mounted
 Housing & Finish : Die Cast Aluminium + PC Diffuser

Applications

Houses, Offices, Hospitals, Showrooms



Dimension (in mm)

PRODUCT CODE	LENGTH	WIDTH	HEIGHT	CUT-OUT
LPS40IP65	595	595	19	570 X 570
LKM2240IP65	595	595	35	570 X 570
LPSD40	595	595	19	570 X 570

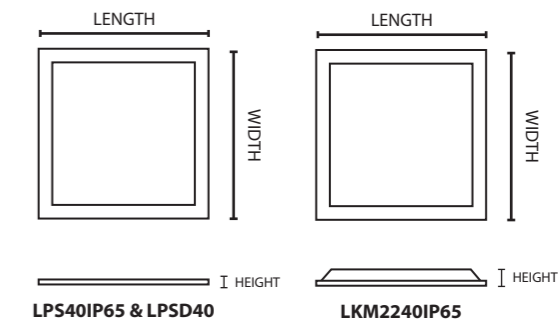

Product Features

Rated Life : 50000 Hrs
 Mounting Type : Recess Mounted
 Housing & Finish : Die Cast Aluminium + PC Diffuser

Applications

Houses, Offices, Hospitals, Showrooms



DURO NEO LED SLIM PANEL



DURO NEO LED SLIM PANEL

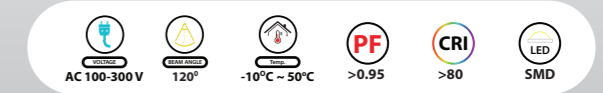

Product Code	Wattage	Voltage	Power Factor	System Luminous Efficacy	CRI	LED Light Source	Beam Angle	CCT	IP Rating	Surge Voltage	THD
LDNS03	3W	230V	>0.95	80 LM/W	>80	SMD	120°	WH	IP20	2.5 KV	<15%
LDNS06	6W	230V	>0.95	80 LM/W	>80	SMD	120°	WW	IP20	2.5 KV	<15%
LDNS09	9W	230V	>0.95	80 LM/W	>80	SMD	120°	NWH	IP20	2.5 KV	<15%
LDNS12	12W	230V	>0.95	80 LM/W	>80	SMD	120°	WH	IP20	2.5 KV	<15%
LDNS18	18W	230V	>0.95	80 LM/W	>80	SMD	120°	WW	IP20	2.5 KV	<15%
LDNS24	24W	230V	>0.95	80 LM/W	>80	SMD	120°	NWH	IP20	2.5 KV	<15%

Dimension (in mm)

PRODUCT CODE	LENGTH	WIDTH	HEIGHT	CUT-OUT
LDNS03	85	85	26	75 X 75
LDNS06	120	120	26	105 X 105
LDNS09	150	150	26	135 X 135
LDNS12	170	170	26	155 X 155
LDNS18	225	225	26	205 X 205
LDNS24	300	300	26	280 X 280

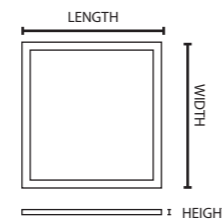

Product Features

Rated Life : 30000 Hrs
 Mounting Type : Recess Mounted
 Housing & Finish : Die Cast Aluminium + PC Diffuser

Applications

Houses, Offices, Hospitals, Showrooms



Product Code	Wattage	Voltage	Power Factor	System Luminous Efficacy	CRI	LED Light Source	Beam Angle	CCT	IP Rating	Surge Voltage	THD
LDNR03	3W	230V	>0.95	80 LM/W	>80	SMD	120°	WH	IP20	2.5 KV	<15%
LDNR06	6W	230V	>0.95	80 LM/W	>80	SMD	120°	WW	IP20	2.5 KV	<15%
LDNR09	9W	230V	>0.95	80 LM/W	>80	SMD	120°	NWH	IP20	2.5 KV	<15%
LDNR12	12W	230V	>0.95	80 LM/W	>80	SMD	120°	WH	IP20	2.5 KV	<15%
LDNR18	18W	230V	>0.95	80 LM/W	>80	SMD	120°	WW	IP20	2.5 KV	<15%
LDNR24	24W	230V	>0.95	80 LM/W	>80	SMD	120°	NWH	IP20	2.5 KV	<15%

Dimension (in mm)

PRODUCT CODE	DIA	HEIGHT
LDNS03	85	26
LDNS06	120	26
LDNS09	150	26
LDNS12	170	26
LDNS18	225	26
LDNS24	300	26

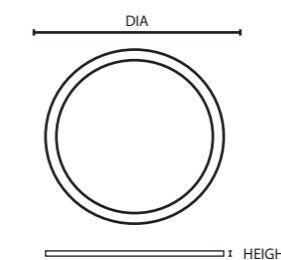

Product Features

Rated Life : 30000 Hrs
 Mounting Type : Recess Mounted
 Housing & Finish : Die Cast Aluminium + PC Diffuser

Applications

Houses, Offices, Hospitals, Showrooms





SURFACE PANEL LIGHTS



IRIS LED SURFACE PANEL

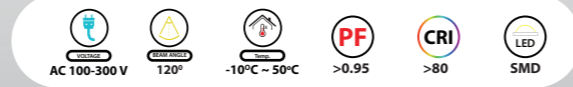

IRIS LED SURFACE PANEL

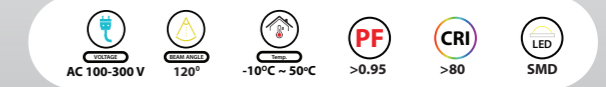

Product Code	Wattage	Voltage	Power Factor	System Luminous Efficacy	CRI	LED Light Source	Beam Angle	CCT	IP Rating	Surge Voltage	THD
LNPSRS03	3W	230V	>0.95	100 LM/W	>80	SMD	120°	WH,WW	IP20	4 KV	<15%
LNPSRS06	6W	230V	>0.95	100 LM/W	>80	SMD	120°	WH,WW NW	IP20	4 KV	<15%
LNPSRS12	12W	230V	>0.95	100 LM/W	>80	SMD	120°	WH,WW NW	IP20	4 KV	<15%
LNPSRS18	18W	230V	>0.95	100 LM/W	>80	SMD	120°	WH,WW NW	IP20	4 KV	<15%
LNPSRS30	30W	230V	>0.95	100 LM/W	>80	SMD	120°	WH,WW NW	IP20	4 KV	<15%
LNPSRS40	40W	230V	>0.95	100 LM/W	>80	SMD	120°	WH,WW NW	IP20	4 KV	<15%
LNPSRS48	48W	230V	>0.95	100 LM/W	>80	SMD	120°	WH	IP20	4 KV	<15%

Product Code	Wattage	Voltage	Power Factor	System Luminous Efficacy	CRI	LED Light Source	Beam Angle	CCT	IP Rating	Surge Voltage	THD
LNPSRR03	3W	230V	>0.95	100 LM/W	>80	SMD	120°	WH,WW	IP20	4 KV	<15%
LNPSRR06	6W	230V	>0.95	100 LM/W	>80	SMD	120°	WH,WW NW	IP20	4 KV	<15%
LNPSRR12	12W	230V	>0.95	100 LM/W	>80	SMD	120°	WH,WW NW	IP20	4 KV	<15%
LNPSRR18	18W	230V	>0.95	100 LM/W	>80	SMD	120°	WH,WW NW	IP20	4 KV	<15%
LNPSRR30	30W	230V	>0.95	100 LM/W	>80	SMD	120°	WH,WW NW	IP20	4 KV	<15%

Dimension (in mm)

PRODUCT CODE	LENGTH	WIDTH	HEIGHT
LNPSRS03	88	88	35
LNPSRS06	118	118	35
LNPSRS12	178	178	35
LNPSRS18	240	240	35
LNPSRS30	300	300	35
LNPSRS40	600	600	35
LNPSRS48	1200	300	35

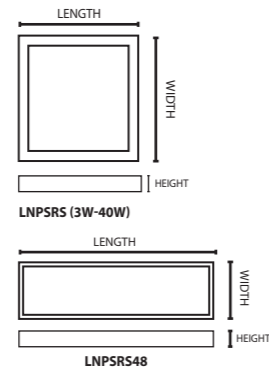

Product Features

- Rated Life : 50000 Hrs
- Mounting Type : Surface Mounted
- Housing & Finish : Die Cast Aluminium + PC Diffuser

Applications

Houses, Offices, Hospitals, Showrooms

Dimension (in mm)

PRODUCT CODE	DIA	HEIGHT
LNPSRR03	88	35
LNPSRR06	118	35
LNPSRR12	178	35
LNPSRR18	240	35
LNPSRR30	300	35

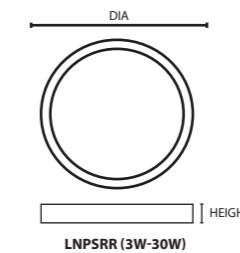

Product Features

- Rated Life : 50000 Hrs
- Mounting Type : Surface Mounted
- Housing & Finish : Die Cast Aluminium + PC Diffuser

Applications

Houses, Offices, Hospitals, Showrooms

LISO LED TRIMLESS SURFACE PANELS

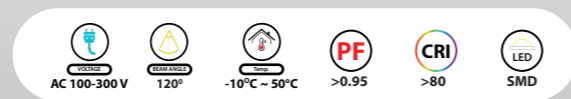
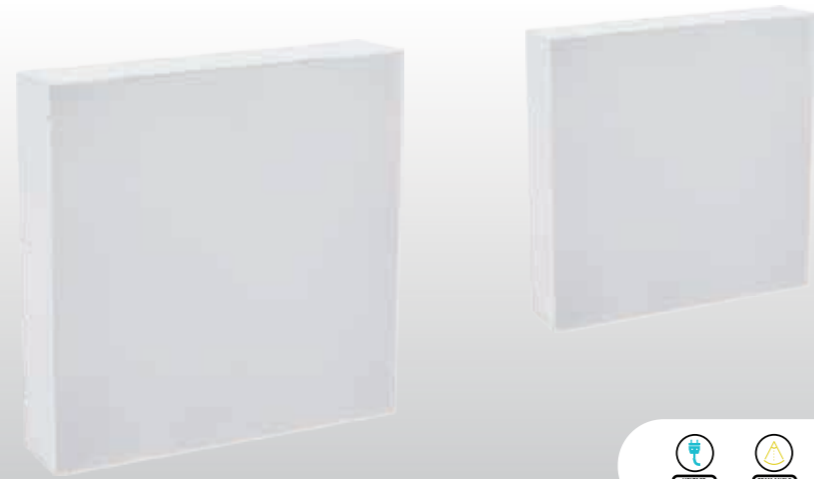

LISO LED TRIMLESS SURFACE PANELS

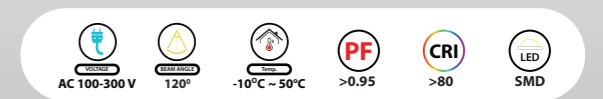

Product Code	Wattage	Voltage	Power Factor	System Luminous Efficacy	CRI	LED Light Source	Beam Angle	CCT	IP Rating	Surge Voltage	THD
LCL6NS	6W	230V	>0.95	100 LM/W	>80	SMD	120°	WH,WW 3 IN 1	IP20	3 KV	<15%
LCL15NS	15W	230V	>0.95	100 LM/W	>80	SMD	120°	WH,WW 3 IN 1	IP20	3 KV	<15%
LCL20NS	20W	230V	>0.95	100 LM/W	>80	SMD	120°	WH,WW 3 IN 1	IP20	3 KV	<15%

Dimension (in mm)

PRODUCT CODE	LENGTH	WIDTH	HEIGHT
LCL6NS	100	100	30
LCL15NS	140	140	30
LCL20NS	180	180	30

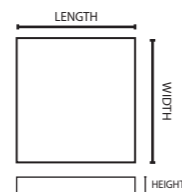

Product Features

Rated Life : 30000 Hrs
 Mounting Type : Surface Mounted
 Housing & Finish : ABS Plastic Body + PC Diffuser

Applications

Houses, Offices, Hospitals, Showrooms

Product Code	Wattage	Voltage	Power Factor	System Luminous Efficacy	CRI	LED Light Source	Beam Angle	CCT	IP Rating	Surge Voltage	THD
LCL6NR	6W	230V	>0.95	100 LM/W	>80	SMD	120°	WH,WW 3 IN 1	IP20	3 KV	<15%
LCL15NR	15W	230V	>0.95	100 LM/W	>80	SMD	120°	WH,WW 3 IN 1	IP20	3 KV	<15%
LCL20NR	20W	230V	>0.95	100 LM/W	>80	SMD	120°	WH,WW 3 IN 1	IP20	3 KV	<15%

Dimension (in mm)

PRODUCT CODE	DIA	HEIGHT
LCL6NR	100	30
LCL15NR	140	30
LCL20NR	180	30

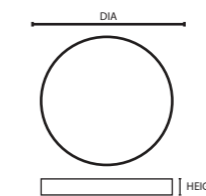

Product Features

Rated Life : 30000 Hrs
 Mounting Type : Surface Mounted
 Housing & Finish : ABS Plastic Body + PC Diffuser

Applications

Houses, Offices, Hospitals, Showrooms

LISO DOB LED TRIMLESS SURFACE PANEL

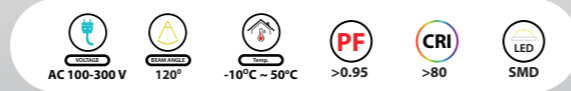
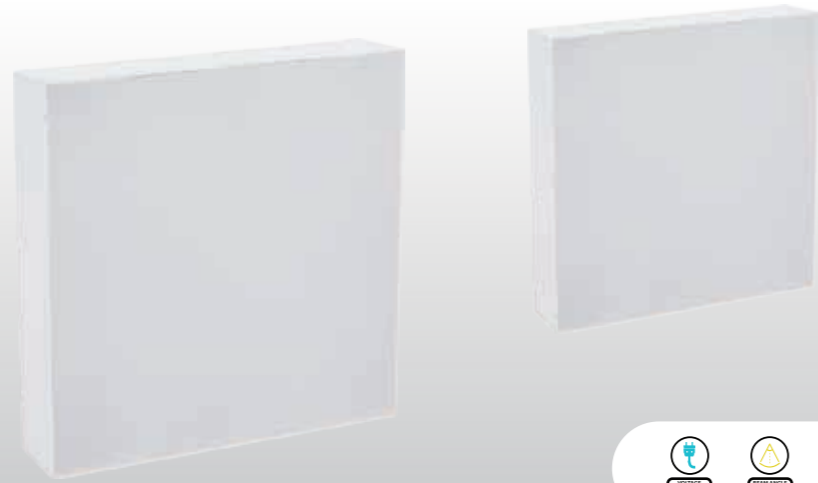

LISO DOB LED TRIMLESS SURFACE PANEL

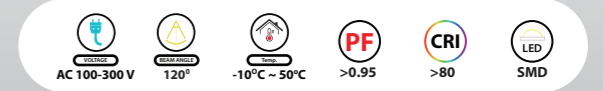

Product Code	Wattage	Voltage	Power Factor	System Luminous Efficacy	CRI	LED Light Source	Beam Angle	CCT	IP Rating	Surge Voltage	THD
LCL8NS	8W	230V	>0.95	100 LM/W	>80	SMD	120°	WH,WW	IP20	3 KV	<15%
LCL12NS	12W	230V	>0.95	100 LM/W	>80	SMD	120°	WH,WW	IP20	3 KV	<15%
LCL18NS	18W	230V	>0.95	100 LM/W	>80	SMD	120°	WH,WW	IP20	3 KV	<15%

Dimension (in mm)

PRODUCT CODE	LENGTH	WIDTH	HEIGHT
LCL8NS	90	90	25
LCL12NS	120	120	25
LCL18NS	155	155	25

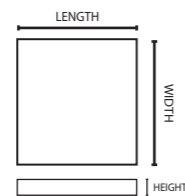

Product Features

Rated Life : 30000 Hrs
 Mounting Type : Surface Mounted
 Housing & Finish : ABS Plastic Body + PC Diffuser

Applications

Houses, Offices, Hospitals, Showrooms

Product Code	Wattage	Voltage	Power Factor	System Luminous Efficacy	CRI	LED Light Source	Beam Angle	CCT	IP Rating	Surge Voltage	THD
LCL8NR	8W	230V	>0.95	100 LM/W	>80	SMD	120°	WH,WW	IP20	3 KV	<15%
LCL12NR	12W	230V	>0.95	100 LM/W	>80	SMD	120°	WH,WW	IP20	3 KV	<15%
LCL18NR	18W	230V	>0.95	100 LM/W	>80	SMD	120°	WH,WW	IP20	3 KV	<15%

PRODUCT CODE	DIA	HEIGHT
LCL8NR	90	25
LCL12NR	120	25
LCL18NR	155	25

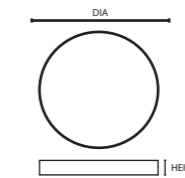

Product Features

Rated Life : 30000 Hrs
 Mounting Type : Surface Mounted
 Housing & Finish : ABS Plastic Body + PC Diffuser

Applications

Houses, Offices, Hospitals, Showrooms



**LIVIANO
LED SLIM PANEL**

LIVIANO LED SLIM PANEL



LIVIANO LED SLIM PANEL



Product Code	Wattage	Voltage	Power Factor	System Luminous Efficacy	CRI	LED Light Source	Beam Angle	CCT	IP Rating	Surge Voltage	THD
LIPR03 N	3W	230V	>0.95	100 LM/W	>80	SMD	120°	WH,WW NW	IP20	3 KV	<15%
LIPR06 N	6W	230V	>0.95	100 LM/W	>80	SMD	120°	WH,WW NW	IP20	3 KV	<15%
LIPR12 N	12W	230V	>0.95	100 LM/W	>80	SMD	120°	WH,WW NW	IP20	3 KV	<15%
LIPR15 N	15W	230V	>0.95	100 LM/W	>80	SMD	120°	WH,WW NW	IP20	3 KV	<15%
LIPR18 N	18W	230V	>0.95	100 LM/W	>80	SMD	120°	WH,WW NW	IP20	3 KV	<15%

Product Code	Wattage	Voltage	Power Factor	System Luminous Efficacy	CRI	LED Light Source	Beam Angle	CCT	IP Rating	Surge Voltage	THD
LIPS03 N	3W	230V	>0.95	100 LM/W	>80	SMD	120°	WH,WW NW	IP20	3 KV	<15%
LIPS06 N	6W	230V	>0.95	100 LM/W	>80	SMD	120°	WH,WW NW	IP20	3 KV	<15%
LIPS12 N	12W	230V	>0.95	100 LM/W	>80	SMD	120°	WH,WW NW	IP20	3 KV	<15%
LIPS15 N	15W	230V	>0.95	100 LM/W	>80	SMD	120°	WH,WW NW	IP20	3 KV	<15%
LIPS18 N	18W	230V	>0.95	100 LM/W	>80	SMD	120°	WH,WW NW	IP20	3 KV	<15%

Dimension (in mm)

PRODUCT CODE	DIA	HEIGHT	CUT-OUT
LIPR03 N	82	25	70
LIPR06 N	118	25	100
LIPR12 N	168	25	155
LIPR15 N	168	25	155
LIPR18 N	220	25	200

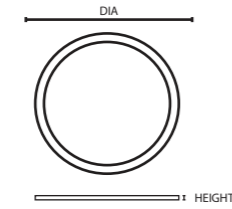

Product Features

- Rated Life : 30000 Hrs
- Mounting Type : Recess Mounted
- Housing & Finish : Die Cast Aluminium + PC Diffuser

Applications

Houses, Offices, Hospitals, Showrooms

Dimension (in mm)

PRODUCT CODE	LENGTH	WIDTH	HEIGHT	CUT-OUT
LIPS03 N	82	82	25	70 X 70
LIPS06 N	118	118	25	100 X 100
LIPS12 N	168	168	25	155 X 155
LIPS15 N	168	168	25	155 X 155
LIPS18 N	220	220	25	200 X 200

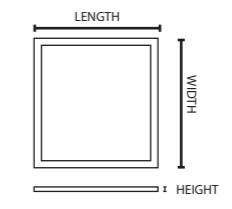

Product Features

- Rated Life : 30000 Hrs
- Mounting Type : Recess Mounted
- Housing & Finish : Die Cast Aluminium + PC Diffuser

Applications

Houses, Offices, Hospitals, Showrooms



LED DOWNLIGHTS

APTO ADJUSTABLE CUTOUT LED DOWNLIGHTS

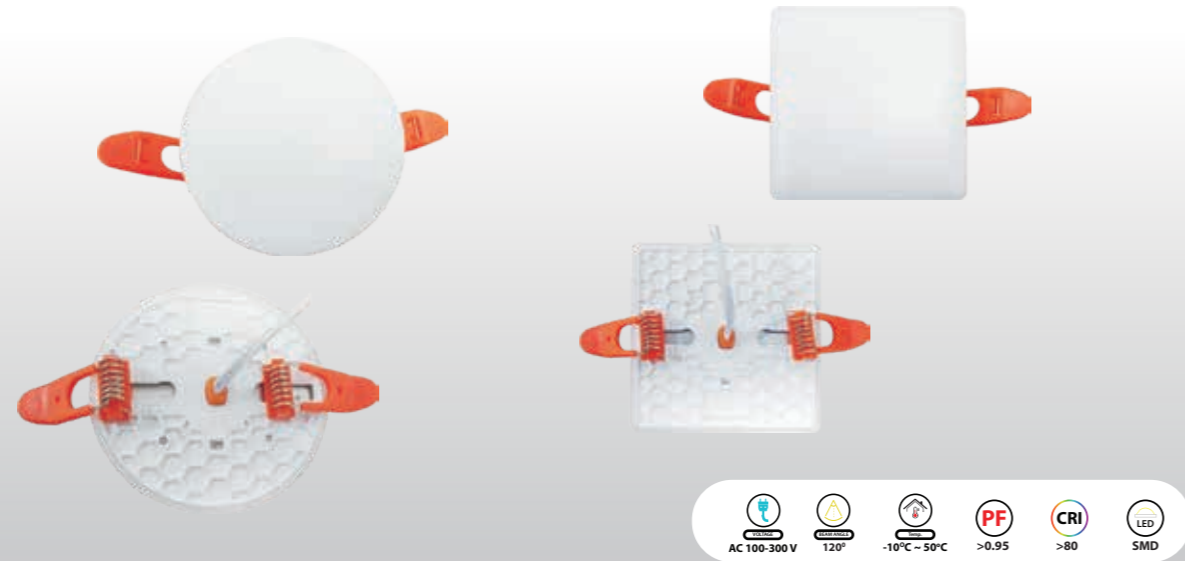

Product Code	Wattage	Voltage	Power Factor	System Luminous Efficacy	CRI	LED Light Source	Beam Angle	CCT	IP Rating	Surge Voltage	THD
LDAR06	6W	230V	>0.95	100 LM/W	>80	SMD	120°	WH,WW	IP20	3 KV	<15%
LDAR12	12W	230V	>0.95	100 LM/W	>80	SMD	120°	WH,WW	IP20	3 KV	<15%
LDAS06	6W	230V	>0.95	100 LM/W	>80	SMD	120°	WH,WW	IP20	3 KV	<15%
LDAS12	12W	230V	>0.95	100 LM/W	>80	SMD	120°	WH,WW	IP20	3 KV	<15%

Dimension (in mm)

PRODUCT CODE	DIA	HEIGHT	CUT-OUT
LDAR06	90	22	50-70
LDAR12	120	22	50-100

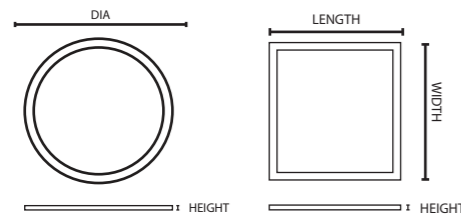

Dimension (in mm)

PRODUCT CODE	LENGTH	WIDTH	HEIGHT	CUT-OUT
LDAS06	90	90	22	50-70
LDAS12	120	120	22	50-100

Product Features

- Rated Life : 30000 Hrs
- Mounting Type : Recess Mounted
- Housing & Finish : Die Cast Aluminium + PC Diffuser

Applications

Houses, Offices, Hospitals, Showrooms

DURO JUNCTION BOX LED LIGHTS

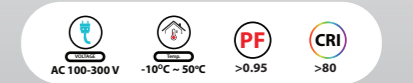

Product Code	Wattage	Voltage	Power Factor	System Luminous Efficacy	CRI	LED Light Source	Beam Angle	CCT	IP Rating	Surge Voltage	THD
LDRJB03N	3W	230V	>0.95	100 LM/W	>80	SMD	120°	WH,WW	IP20	3 KV	<15%
LDRJB03	3W	230V	>0.95	100 LM/W	>80	COB	60°	WH,WW	IP20	3 KV	<15%
LDRJBCOB03	3W	230V	>0.95	100 LM/W	>80	COB	60°	WH,WW	IP20	3 KV	<15%
LDR03	3W	230V	>0.95	100 LM/W	>80	SMD	120°	WH,WW	IP20	3 KV	<15%
LDR05	5W	230V	>0.95	100 LM/W	>80	SMD	120°	WH,WW	IP20	3 KV	<15%
LDR05D	5W	230V	>0.95	100 LM/W	>80	SMD	120°	WH,WW	IP20	3 KV	<15%
LDR07D	7W	230V	>0.95	100 LM/W	>80	SMD	120°	WH,WW	IP20	3 KV	<15%

Dimension (in mm)

PRODUCT CODE	DIA	HEIGHT	CUT-OUT
LDRJB03N	79	31	39.5
LDRJB03	64.5	34.7	38
LDRJBCOB03	70	35	42
LDR03	70.3	37.5	47.5
LDR05	97.56	44.4	63.1
LDR05D	108	25	68
LDR07D	108	25	68

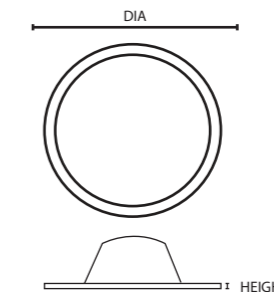

Product Features

- Rated Life : 30000 Hrs
- Mounting Type : Recess Mounted
- Housing & Finish : Die Cast Aluminium + PC Diffuser

Applications

Houses, Offices, Hospitals, Showrooms



LED DOWNLIGHTS

DURO PVC BODY DOWNLIGHTS



DURO METAL BODY DOWNLIGHTS

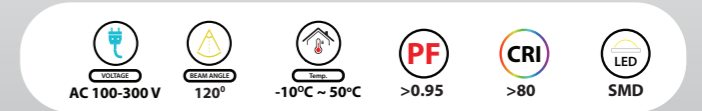
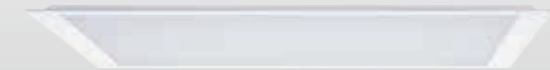

Product Code	Wattage	Voltage	Power Factor	System Luminous Efficacy	CRI	LED Light Source	Beam Angle	CCT	IP Rating	Surge Voltage	THD
LDR15	15W	230V	>0.95	100 LM/W	>80	SMD	120°	WW	IP20	4 KV	<15%
LDR20	20W	230V	>0.95	100 LM/W	>80	SMD	120°	WW	IP20	4 KV	<15%
LDS07	7W	230V	>0.95	100 LM/W	>80	SMD	120°	WH,WW NW	IP20	4 KV	<15%
LDS15	15W	230V	>0.95	100 LM/W	>80	SMD	120°	WH,WW NW	IP20	4 KV	<15%
LDS22	22W	230V	>0.95	100 LM/W	>80	SMD	120°	WW,NW	IP20	4 KV	<15%

Dimension (in mm)

PRODUCT CODE	DIA	HEIGHT	CUT-OUT
LDR15	166	36	150
LDR20	220	36	205

PRODUCT CODE	LENGTH	WIDTH	HEIGHT	CUT-OUT
LDS07	116	116	36	100 x 100
LDS15	166	166	36	150 x 150
LDS22	220	220	36	205 x 205

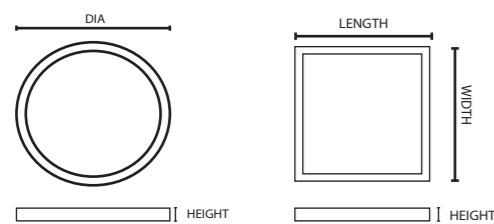

Product Features

Rated Life : 30000 Hrs
 Mounting Type : Recess Mounted
 Housing & Finish : Die Cast Aluminium + PC Diffuser

Applications

Houses, Offices, Hospitals, Showrooms



Product Code	Wattage	Voltage	Power Factor	System Luminous Efficacy	CRI	LED Light Source	Beam Angle	CCT	IP Rating	Surge Voltage	THD
LDR07 MTL	7W	230V	>0.95	100 LM/W	>80	SMD	120°	WH	IP20	4 KV	<15%
LDR15 MTL	15W	230V	>0.95	100 LM/W	>80	SMD	120°	WH,WW NW	IP20	4 KV	<15%
LDR20 MTL	20W	230V	>0.95	100 LM/W	>80	SMD	120°	WH,WW NW	IP20	4 KV	<15%
LKM2236	36W	230V	>0.95	100 LM/W	>80	SMD	120°	WH	IP20	4 KV	<15%
LKM2240	40W	230V	>0.95	100 LM/W	>80	SMD	120°	WH,WW NW	IP20	4 KV	<15%
LKM2245	45W	230V	>0.95	100 LM/W	>80	SMD	120°	WH,WW	IP20	4 KV	<15%
LKM4145	45W	230V	>0.95	100 LM/W	>80	SMD	120°	WH,WW	IP20	4 KV	<15%

Dimension (in mm)

PRODUCT CODE	LENGTH	WIDTH	HEIGHT	CUT-OUT
LKM2236	595	595	35	570 X 570
LKM2240	595	595	35	570 X 570
LKM2245	595	595	35	570 X 570
LKM4145	1195	295	35	1175 X 275

PRODUCT CODE	DIA	HEIGHT	CUT-OUT
LDR07 MTL	120.4	57.6	91.2
LDR15 MTL	188	78	135
LDS20 MTL	185	32	145

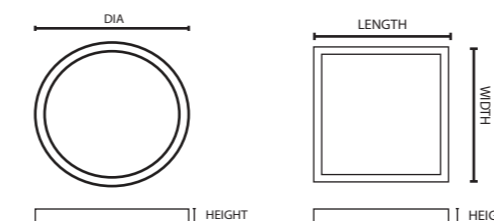

Product Features

Rated Life : 50000 Hrs
 Mounting Type : Recess Mounted
 Housing & Finish : Die Cast Aluminium + PC Diffuser

Applications

Houses, Offices, Hospitals, Showrooms



DURO BACKLIT LED SURFACE PANEL



Product Code	Wattage	Voltage	Power Factor	System Luminous Efficacy	CRI	LED Light Source	Beam Angle	CCT	IP Rating	Surge Voltage	THD
LKMSRS40N	40W	230V	>0.9	100 LM/W	>75	SMD	120°	WH,WW	IP20	1.5 KV	<15%
LKMSRS40	40W	230V	>0.95	100 LM/W	>80	SMD	120°	WH,WW	IP20	4 KV	<15%
LKMSRS45	45W	230V	>0.95	100 LM/W	>80	SMD	120°	WH,WW	IP20	4 KV	<15%
LKMSRS4145	45W	230V	>0.95	100 LM/W	>80	SMD	120°	WH,WW	IP20	4 KV	<15%

Dimension (in mm)

PRODUCT CODE	LENGTH	WIDTH	HEIGHT
LKMSRS40N	595	595	40
LKMSRS40	595	595	65
LKMSRS45	595	595	65
LKMSRS4145	1200	300	35

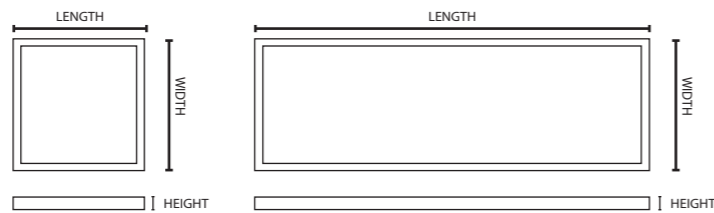

Product Features

- Rated Life : 50000 Hrs
- Mounting Type : Surface Mounted
- Housing & Finish : Die Cast Aluminium + PC Diffuser

Applications

Houses, Offices, Hospitals, Showrooms



FUERA LED OUTDOOR DOWNLIGHTS

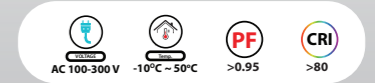
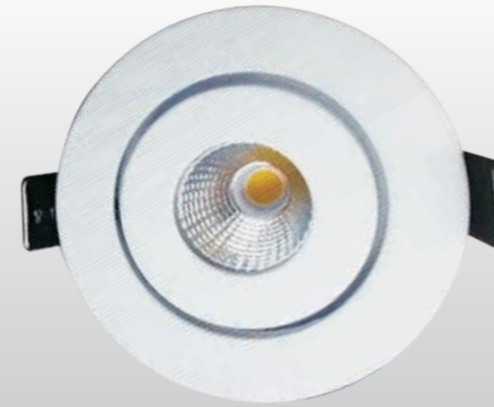

Product Code	Wattage	Voltage	Power Factor	System Luminous Efficacy	CRI	LED Light Source	Beam Angle	CCT	IP Rating	Surge Voltage	THD
LDR4405	5W	230V	>0.95	100 LM/W	>80	SMD	120°	WH,WW NW	IP54	3 KV	<15%
LCOB4405	5W	230V	>0.95	100 LM/W	>80	COB	60°	WH,WW NW	IP54	3 KV	<15%
LDR4412	12W	230V	>0.95	100 LM/W	>80	SMD	120°	WH,WW NW	IP54	3 KV	<15%

PRODUCT CODE	DIA	HEIGHT	CUT-OUT
LDR4405	88	26	90
LCOB4405	64	47	55
LDR4412	145	27	130

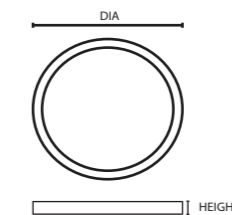

Product Features

- Rated Life : 30000 Hrs
- Mounting Type : Recess Mounted
- Housing & Finish : Die Cast Aluminium + PC Diffuser

Applications

Houses, Offices, Hospitals, Showrooms





***CORVUS
LED COB DOWNLIGHTS***



CORVUS CONCEALED COB/SPOT LED

CORVUS CONCEALED COB/SPOT LED



Product Code	Wattage	Voltage	Power Factor	System Luminous Efficacy	CRI	LED Light Source	Beam Angle	CCT	IP Rating	Surge Voltage	Body & Finish
LSCOBS01	1W	230V	>0.95	90 LM/W	>80	COB	60°	WH,WW,NW	IP20	2 KV	WHITE
LSCOB01	1W	230V	>0.95	90 LM/W	>80	COB	60°	WH,WW,NW	IP20	2 KV	WHITE
LSCR01	1W	230V	>0.95	90 LM/W	>80	COB	60°	WH,WW,NW, BL,RD,GR	IP20	2 KV	STAIN NICKEL
LSCS01	1W	230V	>0.95	90 LM/W	>80	COB	60°	WH,WW, BL,RD,GR	IP20	2 KV	STAIN NICKEL
LSCOBM01	1W	230V	>0.95	90 LM/W	>80	COB	60°	WH,WW	IP20	2 KV	WHITE
LCOB03	3W	230V	>0.95	90 LM/W	>80	COB	60°	WH,WW	IP20	2 KV	WHITE
LSCS03	3W	230V	>0.95	90 LM/W	>80	COB	60°	WH,WW,NW	IP20	2 KV	STAIN NICKEL
LSCR03	3W	230V	>0.95	90 LM/W	>80	COB	60°	WH,WW,NW	IP20	2 KV	STAIN NICKEL

Dimension (in mm)

PRODUCT CODE	DIA	HEIGHT	CUT-OUT
LSCOB01	32.5	18	25
LSCR01	32	19	25
LSCOBM01	42	20.5	35.1
LCOB03	39.5	24.4	26.2
LSCR03	50	34	34.1

PRODUCT CODE	LENGTH	WIDTH	HEIGHT	CUT-OUT
LSCOBS01	30	30	18	25
LSCS01	30	30	18.5	27
LSCS03	50.1	50.1	34.1	34

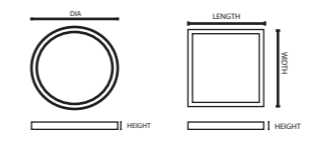

Product Features

- Rated Life : 30000 Hrs
- Mounting Type : Recess Mounted
- Housing & Finish : Die Cast Aluminium + PC Diffuser

Applications

Houses, Offices, Hospitals, Showrooms



CORVUS CONCEALED COB/SPOT LED

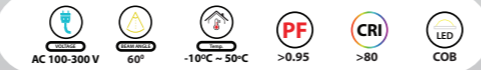

CORVUS ANTI-GALRE LED



Product Code	Wattage	Voltage	Power Factor	System Luminous Efficacy	CRI	LED Light Source	Beam Angle	CCT	IP Rating	Surge Voltage	THD
LCOB04	4W	230V	>0.95	100 LM/W	>80	COB	60°	WH,WW NW	IP20	4 KV	<15%
LCOB07N	7W	230V	>0.95	100 LM/W	>80	COB	60°	WH,WW NW	IP20	4 KV	<15%
LCOB12N	12W	230V	>0.95	100 LM/W	>80	COB	60°	WH,WW NW	IP20	4 KV	<15%
LCOB18N	18W	230V	>0.95	100 LM/W	>80	COB	60°		IP20	4 KV	<15%
LCOB24N	24W	230V	>0.95	100 LM/W	>80	COB	60°	WH,WW NW	IP20	4 KV	<15%
LCOB30N	30W	230V	>0.95	100 LM/W	>80	COB	60°	WH,WW NW	IP20	4 KV	<15%
LCOB50N	50W	230V	>0.95	100 LM/W	>80	COB	60°	WH,WW NW	IP20	4 KV	<15%
LCOB18SQ	18W	230V	>0.95	100 LM/W	>80	COB	60°		IP20	4 KV	<15%
LCOB218SQ	2x18W	230V	>0.95	100 LM/W	>80	COB	60°	WH,WW NW	IP20	4 KV	<15%

Product Code	Wattage	Voltage	Power Factor	System Luminous Efficacy	CRI	LED Light Source	Beam Angle	CCT	IP Rating	Surge Voltage	THD
LAGCOB07	7W	230V	>0.95	100 LM/W	>80	COB	20°	WH,WW NW	IP20	4 KV	<15%
LAGCOB12	12W	230V	>0.95	100 LM/W	>80	COB	25°	WH,WW NW	IP20	4 KV	<15%
LAGCOB18N	18W	230V	>0.95	100 LM/W	>80	COB	60°	WH,WW NW	IP20	4 KV	<15%
LAGCOB30	30W	230V	>0.95	100 LM/W	>80	COB	60°	WH,WW NW	IP20	4 KV	<15%

Dimension (in mm)

PRODUCT CODE	DIA	HEIGHT	CUT-OUT
LAGCOB07	59	65	50
LAGCOB12	83	81	73
LAGCOB18N	90	88	80
LAGCOB30	119	120	108

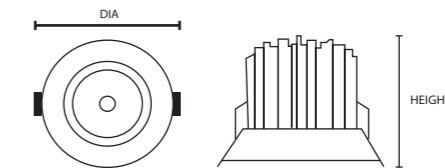

Product Features

- Rated Life : 50000 Hrs
- Mounting Type : Recess Mounted
- Housing & Finish : Die Cast Aluminium + PC Diffuser

Applications

Houses, Offices, Hospitals, Showrooms

Dimension (in mm)

PRODUCT CODE	DIA	HEIGHT	CUT-OUT
LCOB04	85	45	70
LCOB07N	85.3	60.25	66.2
LCOB12N	108	70	88
LCOB18N	128	80	118
LCOB24N	138	79	111
LCOB30N	159	103	135.4
LCOB50N	170.1	120	139.9

PRODUCT CODE	LENGTH	WIDTH	HEIGHT	CUT-OUT
LSCOB18SQ	137	136.8	87.4	125X124
LCOB218SQ	250	136	87	234X124

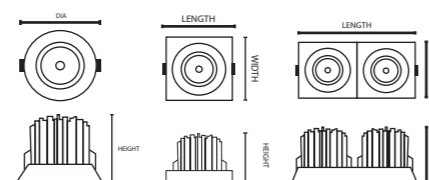

Product Features

- Rated Life : 50000 Hrs
- Mounting Type : Recess Mounted
- Housing & Finish : Die Cast Aluminium + PC Diffuser

Applications

Houses, Offices, Hospitals, Showrooms



CORVUS ANTI-GALRE LED

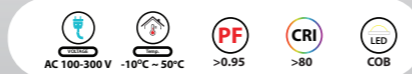

CORVUS ANTI-GALRE LED



Product Code	Wattage	Voltage	Power Factor	System Luminous Efficacy	CRI	LED Light Source	Beam Angle	CCT	IP Rating	Surge Voltage	THD
LAGRCOB07	7W	230V	>0.95	100 LM/W	>80	COB	40°	WH,WW NW	IP20	4 KV	<15%
LAGRCOB12	12W	230V	>0.95	100 LM/W	>80	COB	38°	WH,WW NW	IP20	4 KV	<15%
LAGRCOB18	18W	230V	>0.95	100 LM/W	>80	COB	60°	WH,WW NW	IP20	4 KV	<15%

Dimension (in mm)

PRODUCT CODE	DIA	HEIGHT	CUT-OUT
LAGRCOB07	59	65	50
LAGRCOB12	83	81	73
LAGRCOB18N	95	96	85

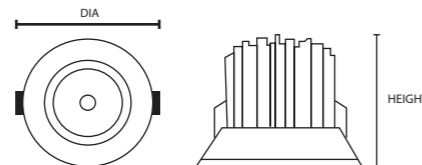

Product Features

- Rated Life : 50000 Hrs
- Mounting Type : Recess Mounted
- Housing & Finish : Die Cast Aluminium + Chrome Reflector

Applications

Houses, Offices, Hospitals, Showrooms

Product Code	Wattage	Voltage	Power Factor	System Luminous Efficacy	CRI	LED Light Source	Beam Angle	CCT	IP Rating	Surge Voltage	THD
BLACK BODY											
LCOB03BK	3W	230V	>0.95	100 LM/W	>80	COB	38°	WH,WW NW	IP20	4 KV	<15%
LAGBCOB07BK	7W	230V	>0.95	100 LM/W	>80	COB	38°	WH,WW NW	IP20	4 KV	<15%
LAGBCOB12BK	12W	230V	>0.95	100 LM/W	>80	COB	38°	WH,WW NW	IP20	4 KV	<15%
LAGBCOB18BK	18W	230V	>0.95	100 LM/W	>80	COB	38°	WH,WW NW	IP20	4 KV	<15%

Product Code	Wattage	Voltage	Power Factor	System Luminous Efficacy	CRI	LED Light Source	Beam Angle	CCT	IP Rating	Surge Voltage	THD
BLACK BODY WITH ROSE GOLD REFLECTOR											
LCOB03RG	3W	230V	>0.95	100 LM/W	>80	COB	38°	WW,NW	IP20	4 KV	<15%
LAGBCOB07RG	7W	230V	>0.95	100 LM/W	>80	COB	38°	WH,WW NW	IP20	4 KV	<15%
LAGBCOB12RG	12W	230V	>0.95	100 LM/W	>80	COB	38°	WW,NW	IP20	4 KV	<15%
LAGBCOB18RG	18W	230V	>0.95	100 LM/W	>80	COB	38°	WH,WW NW	IP20	4 KV	<15%

Dimension (in mm)

PRODUCT CODE	DIA	HEIGHT	CUT-OUT
LCOB03BK	37	32	27
LAGBCOB07BK	59	65	50
LAGBCOB12BK	83	78	71
LAGBCOB18BK	90	88	80
LCOB03RG	37	32	27
LAGBCOB07RG	59	65	50
LAGBCOB12RG	83	81	73
LAGBCOB18RG	95	96	85

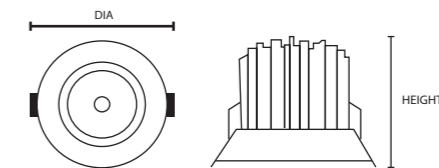

Product Features

- Rated Life : 50000 Hrs
- Mounting Type : Recess Mounted
- Housing & Finish : Die Cast Aluminium

Applications

Houses, Offices, Hospitals, Showrooms



CORVUS LINEAR LED COB LIGHTS

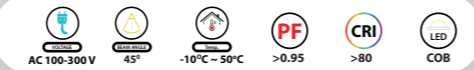
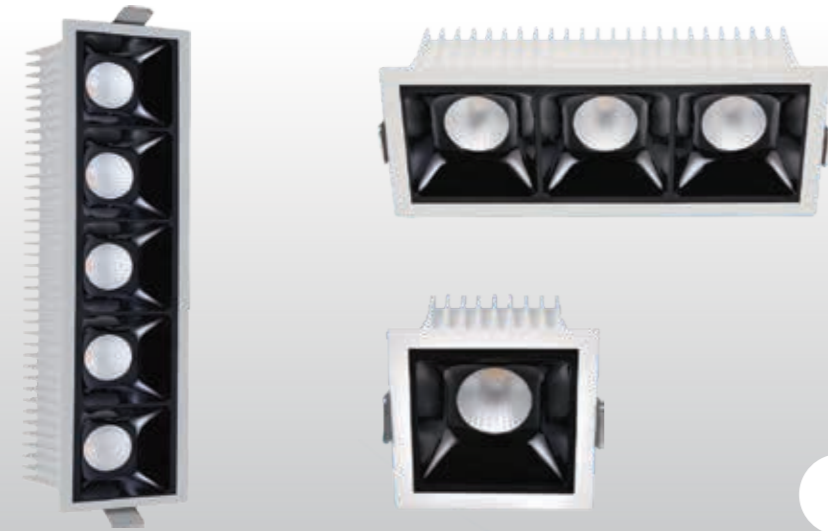

CORVUS SURFACE LED COB LIGHTS

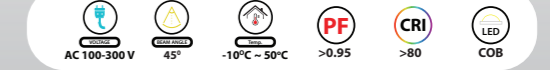

Product Code	Wattage	Voltage	Power Factor	System Luminous Efficacy	CRI	LED Light Source	Beam Angle	CCT	IP Rating	Surge Voltage	THD
LCOB106SQ	6W	230V	>0.95	100 LM/W	>80	COB	45°	WH,WW NW	IP20	4 KV	<15%
LCOB306SQ	18W	230V	>0.95	100 LM/W	>80	COB	45°	WH,WW NW	IP20	4 KV	<15%
LCOB506SQ	30W	230V	>0.95	100 LM/W	>80	COB	45°	WH,WW NW	IP20	4 KV	<15%

Dimension (in mm)

PRODUCT CODE	LENGTH	WIDTH	HEIGHT	CUT-OUT
LCOB106SQ	65	65	45	55X55
LCOB306SQ	165	65	45	146X55
LCOB506SQ	250	62.5	49	240X55

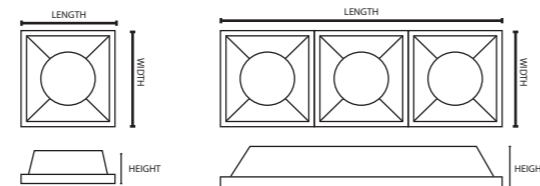

Product Features

- Rated Life : 50000 Hrs
- Mounting Type : Recess Mounted
- Housing & Finish : Die Cast Aluminium + PC Lens Diffuser

Applications

Houses, Offices, Hospitals, Showrooms

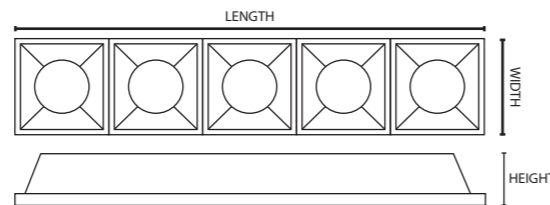

Product Code	Wattage	Voltage	Power Factor	System Luminous Efficacy	CRI	LED Light Source	Beam Angle	CCT	IP Rating	Surge Voltage	THD
LCOBSRR07	7W	230V	>0.95	100 LM/W	>80	COB	45°	WH,WW NW	IP20	4 KV	<15%
LCOBSRR07	7W	230V	>0.95	100 LM/W	>80	COB	45°	WH,WW NW	IP20	4 KV	<15%
LCOBSRR12	12W	230V	>0.95	100 LM/W	>80	COB	45°	WH,WW NW	IP20	4 KV	<15%
LCOBSRR12	12W	230V	>0.95	100 LM/W	>80	COB	45°	WH,WW NW	IP20	4 KV	<15%
LCOBSRS07	7W	230V	>0.95	100 LM/W	>80	COB	45°	WH,WW NW	IP20	4 KV	<15%
LCOBSRS07	7W	230V	>0.95	100 LM/W	>80	COB	45°	WH,WW NW	IP20	4 KV	<15%
LCOBSRS12	12W	230V	>0.95	100 LM/W	>80	COB	45°	WH,WW NW	IP20	4 KV	<15%
LCOBSRS12	12W	230V	>0.95	100 LM/W	>80	COB	45°	WH,WW NW	IP20	4 KV	<15%
LCOBSRR18	18W	230V	>0.95	100 LM/W	>80	COB	45°	WH,WW NW	IP20	4 KV	<15%
LCOBSRR18	18W	230V	>0.95	100 LM/W	>80	COB	45°	WH,WW NW	IP20	4 KV	<15%
LCOBSRR30	30W	230V	>0.95	100 LM/W	>80	COB	45°	WH,WW NW	IP20	4 KV	<15%
LCOBSRR30	30W	230V	>0.95	100 LM/W	>80	COB	45°	WH,WW NW	IP20	4 KV	<15%

Dimension (in mm)

PRODUCT CODE	DIA	HEIGHT
LCOBSRR07	55	68
LCOBSRR07	55	68
LCOBSRR12	76	100
LCOBSRR12	76	100
LCOBSRR18	93	120
LCOBSRR18	93	120
LCOBSRR30	115	130
LCOBSRR30	115	130

Dimension (in mm)

PRODUCT CODE	LENGTH	WIDTH	HEIGHT
LCOBSRS07	54	54	67
LCOBSRS07	54	54	67
LCOBSRS12	74	74	90
LCOBSRS12	74	74	90

- Product Features**
- Rated Life : 30000 Hrs
 - Mounting Type : Recess Mounted
 - Housing : Die Cast Aluminium + Chrome Reflector
 - Finish : Black body & White body
- Applications**
- Houses, Offices, Hospitals, Showrooms



CORVUS HANGING/OUTDOOR SURFACE



CORVUS DIMMABLE LED COB LIGHTS



Product Code	Wattage	Voltage	Power Factor	System Luminous Efficacy	CRI	LED Light Source	Beam Angle	CCT	IP Rating	Surge Voltage	THD
HANGING LED COB LIGHTS											
LCOBHL12	12W	230V	>0.95	100 LM/W	>80	COB	60°	WH,WW NW	IP20	3 KV	<15%
LCOBBHL12	12W	230V	>0.95	100 LM/W	>80	COB	60°	WH,WW NW	IP20	3 KV	<15%
OUTDOOR SURFACE LED COB LIGHTS (IP54)											
LCOBSRR5406	6W	230V	>0.95	100 LM/W	>80	COB	40°	WW	IP54	3 KV	<15%
LCOBSRR5405	5W	230V	>0.95	100 LM/W	>80	COB	40°	WW	IP54	3 KV	<15%

Dimension (in mm)

PRODUCT CODE	DIA	HEIGHT
LCOBHL12	80	220
LCOBBHL12	80	220
LCOBSRR5406	53	59
LCOBSRR5405	58	17

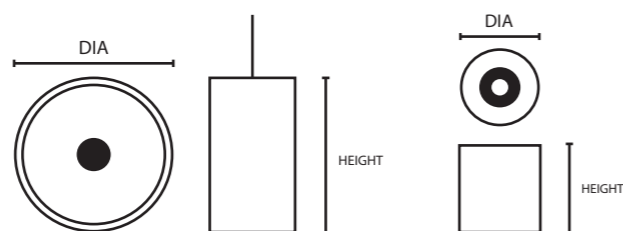

HANGING LIGHT

SURFACE LIGHT

Product Features

- Rated Life : 50000 Hrs
- Mounting Type : Hanging/Surface
- Housing & Finish : Die Cast Aluminium

Applications

Houses, Offices, Hospitals, Showrooms

Product Code	Wattage	Voltage	Power Factor	System Luminous Efficacy	CRI	LED Light Source	Beam Angle	CCT	IP Rating	Surge Voltage	THD
LCOBD07	7W	230V	>0.95	100 LM/W	>80	COB	60°	WH,WW NW	IP20	4 KV	<15%
LCOBD12	12W	230V	>0.95	100 LM/W	>80	COB	60°	WH,WW NW	IP20	4 KV	<15%
LCOBD18	18W	230V	>0.95	100 LM/W	>80	COB	60°	WH,WW NW	IP20	4 KV	<15%
LCOBD24	24W	230V	>0.95	100 LM/W	>80	COB	60°	WH,WW NW	IP20	4 KV	<15%
LCOBD30	30W	230V	>0.95	100 LM/W	>80	COB	60°	WH,WW NW	IP20	4 KV	<15%

Dimension (in mm)

PRODUCT CODE	DIA	HEIGHT	CUT-OUT
LCOBD07	85	63	70
LCOBD12	107	78	92
LCOBD18	135	80	115
LCOBD24	136	88	116
LCOBD30	160	98	140

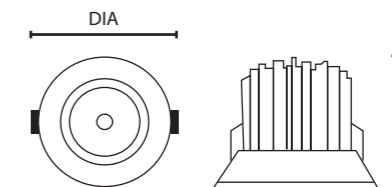

Product Features

- Rated Life : 50000 Hrs
- Mounting Type : Recess Mounted
- Housing & Finish : Die Cast Aluminium + Glass Diffuser
- Dimmable Function : LUKER Dimmable LEDs work with TRAIC Dimmers. They May be some restriction in terms of dimming functionality when used with other lighting dimmers

Applications

Houses, Offices, Hospitals, Showrooms



CORVUS DEEP LED COB LIGHTS

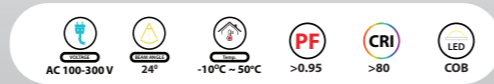
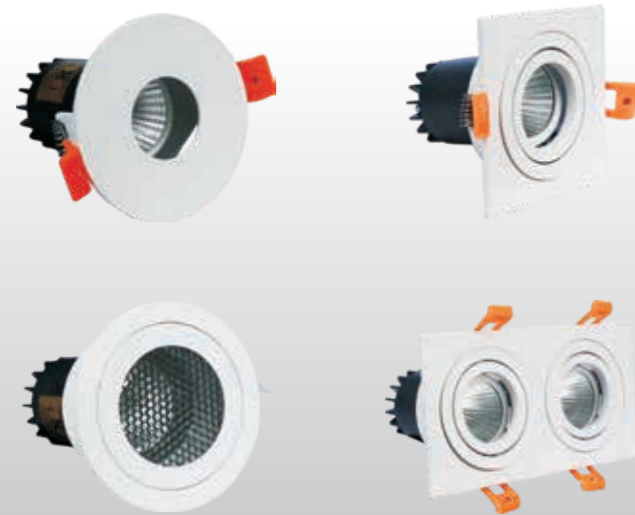

Product Code	Wattage	Voltage	Power Factor	System Luminous Efficacy	CRI	LED Light Source	Beam Angle	CCT	IP Rating	Surge Voltage	THD
LCOBPH12	12W	230V	>0.95	100 LM/W	>80	COB	24°	WH,WW NW	IP20	4 KV	<15%
LCOBHC12	12W	230V	>0.95	100 LM/W	>80	COB	24°	WH,WW NW	IP20	4 KV	<15%
LCOB12SQ	12W	230V	>0.95	100 LM/W	>80	COB	24°	WH,WW NW	IP20	4 KV	<15%
LCOB212SQ	24W	230V	>0.95	100 LM/W	>80	COB	24°	WH,WW NW	IP20	4 KV	<15%

Dimension (in mm)

PRODUCT CODE	DIA	HEIGHT	CUT-OUT
LCOBPH12	88	100	73
LCOBHC12	88	110	70

Dimension (in mm)

PRODUCT CODE	LENGTH	WIDTH	HEIGHT	CUT-OUT
LCOB12SQ	92	92	85	80X80
LCOB212SQ	172	92	85	155X80

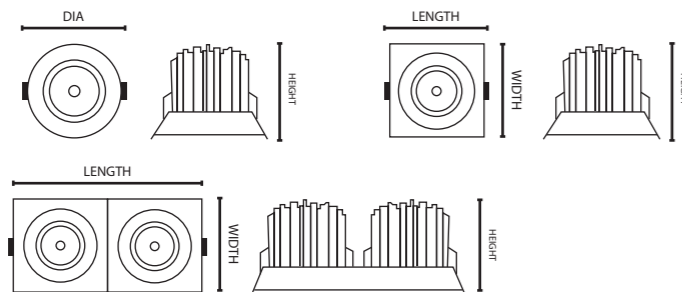

Product Features

- Rated Life : 50000 Hrs
- Mounting Type : Recess Mounted
- Housing & Finish : Die Cast Aluminium

Applications

Houses, Offices, Hospitals, Showrooms



DOMO CEILING LED LIGHTS



Product Code	Wattage	Voltage	Power Factor	System Luminous Efficacy	CRI	LED Light Source	Beam Angle	CCT	IP Rating	Surge Voltage	THD
LCL18S	18W	230V	>0.95	100 LM/W	>80	SMD	120°	WH,WW	IP20	3 KV	<15%
LCL18R	18W	230V	>0.95	100 LM/W	>80	SMD	120°	WH,WW	IP20	3 KV	<15%
LCL07R	7W	230V	>0.95	100 LM/W	>80	SMD	120°	WH,WW	IP20	3 KV	<15%

Dimension (in mm)

PRODUCT CODE	DIA	HEIGHT
LCL18R	320	80
LCL07R	85	51

Dimension (in mm)

PRODUCT CODE	LENGTH	WIDTH	HEIGHT
LCL18S	270	270	60

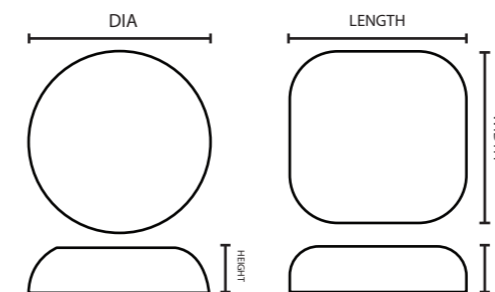

Product Features

- Rated Life : 30000 Hrs
- Mounting Type : Surface Mounted
- Housing & Finish : Polycarbonate body & Diffuser

Applications

Houses, Offices, Hospitals, Showrooms





FERMO
FOCUS LED LIGHT

FERMO FOCUS LED LIGHT

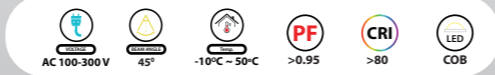

FERMO FOCUS LED LIGHT

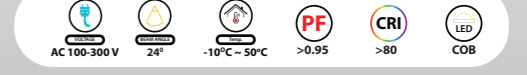

Product Code	Wattage	Voltage	Power Factor	System Luminous Efficacy	CRI	Body Finish	Beam Angle	CCT	IP Rating	Surge Voltage	THD
LSP01 SL	1W	230V	>0.95	100 LM/W	>80	SILVER	45°	WH,WW NW	IP20	3 KV	<15%
LSP01 BK	1W	230V	>0.95	100 LM/W	>80	BLACK	45°	WH,WW NW	IP20	3 KV	<15%
LSP02 SL	1W	230V	>0.95	100 LM/W	>80	SILVER	45°	WH,WW	IP20	3 KV	<15%
LSP02 PKW	1W	230V	>0.95	100 LM/W	>80	WHITE	45°	WH,WW	IP20	3 KV	<15%
LSP04	3W	230V	>0.95	100 LM/W	>80	WHITE	45°	WH,WW	IP20	3 KV	<15%
LSP04 BK	3W	230V	>0.95	100 LM/W	>80	BLACK	45°	WH,WW	IP20	3 KV	<15%

Dimension (in mm)

PRODUCT CODE	DIA	HEIGHT
LSP01 SL	48	91
LSP01 BK	48	91
LSP02 SL	48	88
LSP02 PKW	48	88
LSP04	63	196
LSP04 BK	63	196

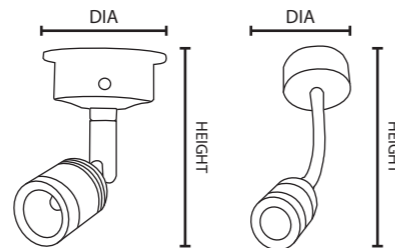

Applications

Houses, Offices, Hospitals, Showrooms

Product Features

- Rated Life : 30000 Hrs
- Mounting Type : Surface Mounted
- Housing : Die Cast Aluminium
- Light Source Rotation : 360° Rotation

Product Code	Wattage	Voltage	Power Factor	System Luminous Efficacy	CRI	LED Light Source	Beam Angle	CCT	IP Rating	Surge Voltage	THD
LSP03	3W	230V	>0.95	100 LM/W	>80	COB	24°	WH,WW	IP20	3 KV	<15%
LSP07	7W	230V	>0.95	100 LM/W	>80	COB	24°	WH,WW	IP20	3 KV	<15%
LSP18	18W	230V	>0.95	100 LM/W	>80	COB	24°	WH,WW	IP20	3 KV	<15%

Dimension (in mm)

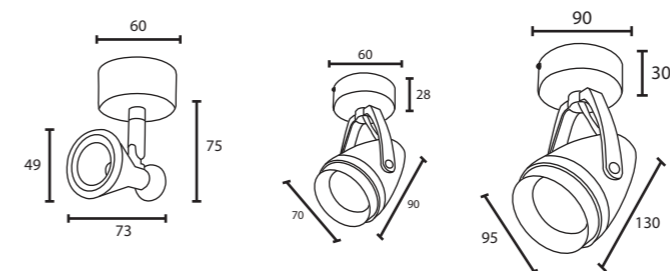

Product Features

- Rated Life : 30000 Hrs
- Mounting Type : Surface Mounted
- Housing : Die Cast Aluminium
- Light Source Rotation : 360° Rotation

Applications

Houses, Offices, Hospitals, Showrooms





FISSO

ZOOM LED LIGHT

FISSO ZOOM LED LIGHT



Product Code	Wattage	Voltage	Power Factor	System Luminous Efficacy	CRI	LED Light Source	Beam Angle	CCT	IP Rating	Surge Voltage	THD
LZCOB07	7W	230V	>0.95	100 LM/W	>80	COB	24°	WH,WW NW	IP20	4 KV	<15%
LZCOB18	18W	230V	>0.95	100 LM/W	>80	COB	24°	WH,WW NW	IP20	4 KV	<15%
LZCOB35	35W	230V	>0.95	100 LM/W	>80	COB	24°	WH,WW NW	IP20	4 KV	<15%
LZCOB50	50W	230V	>0.95	100 LM/W	>80	COB	24°	WH,WW NW	IP20	4 KV	<15%
LZCOB50SQ	50W	230V	>0.95	100 LM/W	>80	COB	24°	WH,WW NW	IP20	4 KV	<15%
LAZCOB12	12W	230V	>0.95	100 LM/W	>80	COB	24°	WH,WW NW	IP20	4 KV	<15%

Dimension (in mm)

PRODUCT CODE	DIA	HEIGHT	CUT-OUT
LZCOB07	89	55	80
LZCOB18	134	128	112
LZCOB35	155	120	148
LZCOB50	200	150	180
LZCOB12	100	183	135

PRODUCT CODE	LENGTH	WIDTH	HEIGHT	CUT-OUT
LZCOB50SQ	240	145	100	207x122

Product Features

Rated Life : 30000 Hrs
 Mounting Type : Surface Mounted
 Housing : Die Cast Aluminium

Applications

Houses, Offices, Hospitals, Showrooms





FUOCO TRACK LED LIGHTS

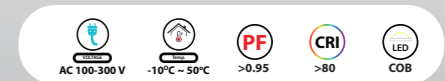

Product Code	Wattage	Voltage	Power Factor	System Luminous Efficacy	CRI	LED Light Source	Beam Angle	CCT	IP Rating	Surge Voltage	THD
LSPT12S	12W	230V	>0.95	100 LM/W	>80	COB	36°	WH,WW NW	IP20	4 KV	<15%
LSPT18	18W	230V	>0.95	100 LM/W	>80	COB	60°	WH,WW NW	IP20	4 KV	<15%
LSPT18S	18W	230V	>0.95	100 LM/W	>80	COB	36°	WH,WW NW	IP20	4 KV	<15%
LSPT24S	24W	230V	>0.95	100 LM/W	>80	COB	36°	WH,WW NW	IP20	4 KV	<15%
LSPT30S	30W	230V	>0.95	100 LM/W	>80	COB	45°	WH,WW NW	IP20	4 KV	<15%

Dimension (in mm)

PRODUCT CODE	A	B	C	D	E
LSPT12S	120.5	34.9	98	75.5	97.5
LSPT18	126	42	121	69.7	24
LSPT18S	120	35	133.2	90	96.8
LSPT24S	120.5	34.7	134	90	95
LSPT30S	120	34.6	149.5	98	97

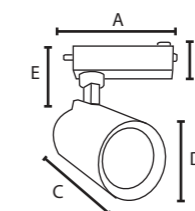

Product Features

- Rated Life : 30000 Hrs
- Mounting Type : Track Mounted
- Housing : Die Cast Aluminium
- Body finish : Black & White Body
- Light Source Rotation : 360° Rotation

Applications

Houses, Offices, Hospitals, Showrooms

FUOCO
TRACK LED LIGHTS





FUOCO

MAGNETIC LED TRACK LIGHTS

FUOCO

MAGNETIC LED TRACK LIGHTS

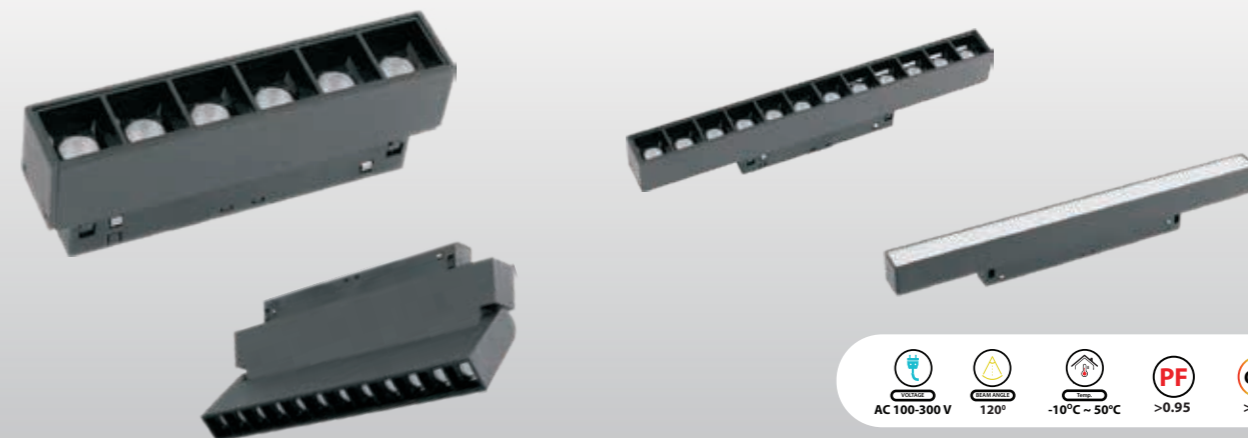

Product Code	Wattage	Voltage	Power Factor	System Luminous Efficacy	CRI	LED Light Source	Beam Angle	CCT	IP Rating	Body Color	THD
LMTLN06	6W	DC 48V	>0.95	100 LM/W	>80	COB	60°	WW, NW	IP20	Black	<15%
LMTLN18	18W	DC 48V	>0.95	100 LM/W	>80	COB	60°	WW, NW	IP20	Black	<15%
LMTLN12A	12W	DC 48V	>0.95	100 LM/W	>80	COB	60°	WW, NW	IP20	Black	<15%
LMTLN20	20W	DC 48V	>0.95	100 LM/W	>80	SMD	60°	WW, NW	IP20	Black	<15%

Dimension (in mm)

PRODUCT CODE	LENGTH	WIDTH	HEIGHT
LMTLN06	108	22	25
LMTLN18	322	22	25
LMTLN12A	220	22	115
LMTLN20	600	22	25

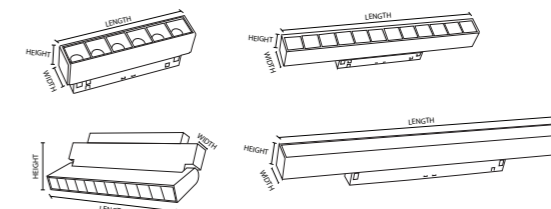

Product Features

- Rated Life : 30000 Hrs
- Mounting Type : Track Mounted
- Housing & Finish : ABS Plastic Body + PC Diffuser

Applications

Houses, Showrooms, Hotels, Resorts, Corridor



FUOCO MAGNETIC LED TRACK LIGHTS

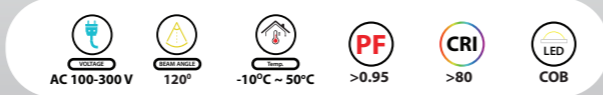

FUOCO MAGNETIC TRACK ACCESSORIES

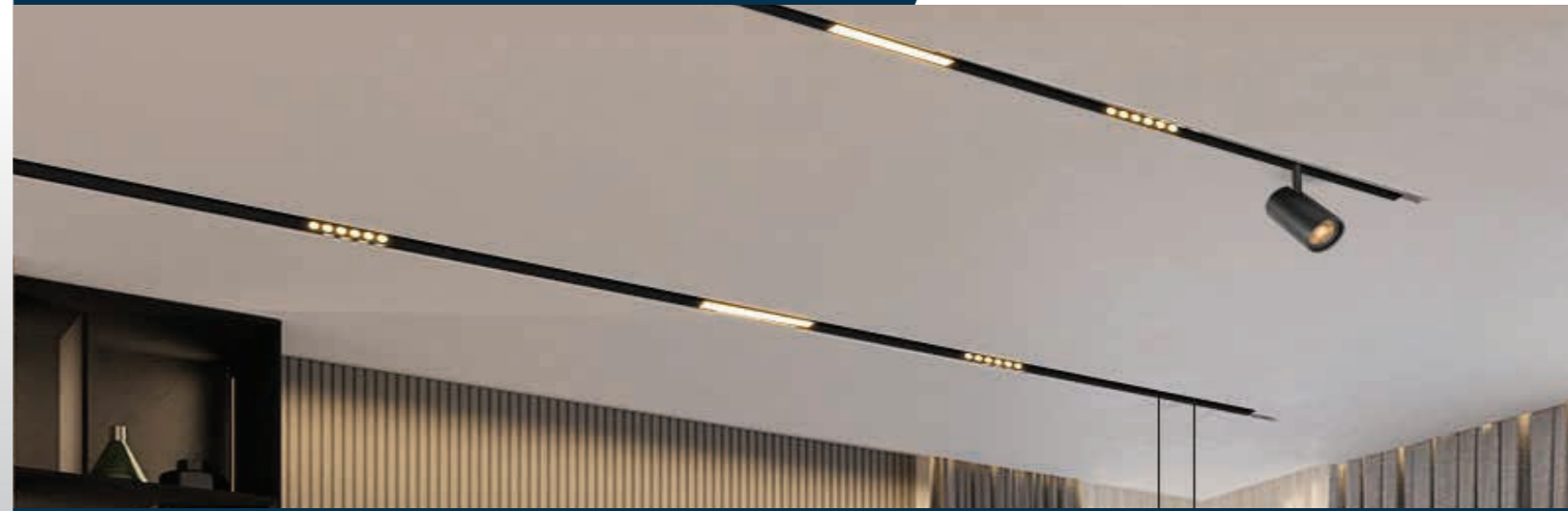

Product Code	Wattage	Voltage	Power Factor	System Luminous Efficacy	CRI	LED Light Source	Beam Angle	CCT	IP Rating	Body Color	THD
LMTSP10	10W	DC 48V	>0.95	100 LM/W	>80	COB	60°	WW, NW	IP20	White	<15%
LMTSP20	20W	DC 48V	>0.95	100 LM/W	>80	COB	60°	WW, NW	IP20	Black	<15%
LMTSP09	20W	DC 48V	>0.95	100 LM/W	>80	COB	60°	WW, NW	IP20	White	<15%

Dimension (in mm)

PRODUCT CODE	DIA	HEIGHT
LMTSP10	48	125
LMTSP20	58	155
LMTSP09	95	34

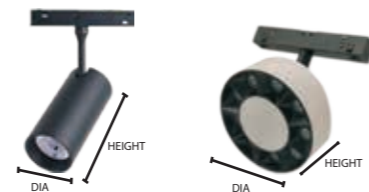

Product Features

Rated Life : 30000 Hrs
 Mounting Type : Track Mounted
 Housing & Finish : ABS Plastic Body + PC Diffuser

Applications

Houses, Showrooms, Hotels, Resorts, Corridor

Surface Track Channel - 1 MTR

MODEL	DIMENSION (IN MM)	BODY COLOR
LMTCH1MBK	1000(L) X 26.5(W) X 53.5 (H)	BLACK

Surface Track Channel - 2 MTR

MODEL	DIMENSION (IN MM)	BODY COLOR
LMTCH2MBK	2000(L) X 26.5(W) X 53.5 (H)	BLACK

Concealed Track Channel - 2 MTR

MODEL	DIMENSION (IN MM)	BODY COLOR
LMTCHRC2MBK	2000(L) X 70(W) X 53.5 (H)	BLACK

Surface Track Fixing Clamp

MODEL	DIMENSION (IN MM)	BODY COLOR
LMTCL	-	-

Wire connector - START

MODEL	DIMENSION (IN MM)	BODY COLOR
LMTHCNC	-	BLACK

Wire connector - STRAIGHT

MODEL	DIMENSION (IN MM)	BODY COLOR
LMTICNC	-	BLACK

Wire connector - CORNER

MODEL	DIMENSION (IN MM)	BODY COLOR
LMTH4CNC	-	BLACK

HORIZONTAL SURFACE - CORNER

MODEL	DIMENSION (IN MM)	BODY COLOR
LMTHCR	1000(L) X 26.5(W) X 53.5 (H)	BLACK

VERTICAL SURFACE - CORNER

MODEL	DIMENSION (IN MM)	BODY COLOR
LMTCH1MBK	80X80	BLACK

MAGNETIC LED DRIVER 100W, 48V

MODEL	DIMENSION (IN MM)	BODY COLOR
LMTDR100	220(L) X 23(W) X 26 (H)	BLACK

MAGNETIC LED DRIVER 200W, 48V

MODEL	DIMENSION (IN MM)	BODY COLOR
LMTDR200	310(L) X 23(W) X 26 (H)	BLACK





LED STRIP - INDOOR



LED STRIP - INDOOR

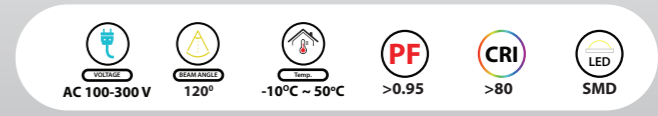
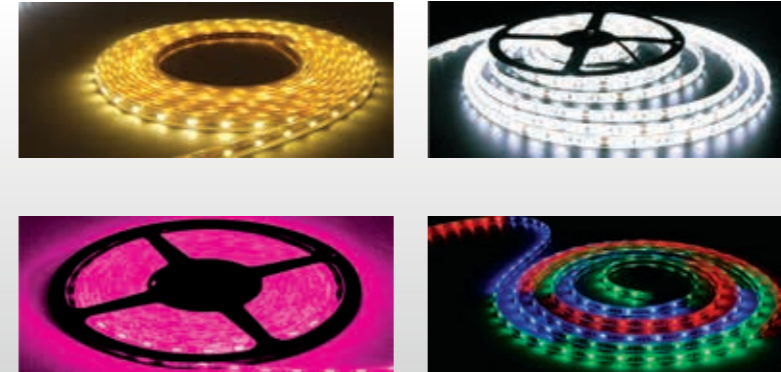

Product Code	Wattage	Voltage	LED's/ Meter	System Luminous Efficacy	CRI	LED Light Source	Beam Angle	CCT	IP Rating	LED Size	STD PKG.
VERO INDOOR STRIP-2835											
LS2835	6W	12V	60	60-70 LM/M	>80	SMD	120°	WH,WW NW,BL,RD,GR	IP20	2835	5M/POLL
LSI2835	6W	12V	60	60-70 LM/M	>80	SMD	120°	PINK	IP20	2835	<15%
LORO INDOOR STRIP-5050											
LS5050	14.6W	230V	60	60-70 LM/M	>80	SMD	120°	WH,WW NW,BL,RD,GR	IP20	5050	<15%
LSI5050	14.6W	230V	60	60-70 LM/M	>80	SMD	120°	PINK / RGB	IP20	5050	<15%

Dimension (in mm)

PRODUCT CODE	LENGTH	WIDTH	HEIGHT
LS2835	5MTR	7.7MM	1MM
LSI2835	5MTR	6.7MM	1MM
LS5050	5MTR	10.1MM	1MM
LSI5050	5MTR	9.5MM	1MM

Product Features

Rated Life : 30000 Hrs
 Mounting Type : Surface mount
 Housing & Finish : Flexible LED PCB

Applications

Houses, Hotels, Restaurants, Resort, Showrooms

LED STRIP - INDOOR





CAPO OUTDOOR LED STRIP- IP65

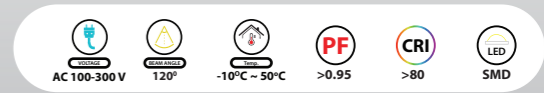
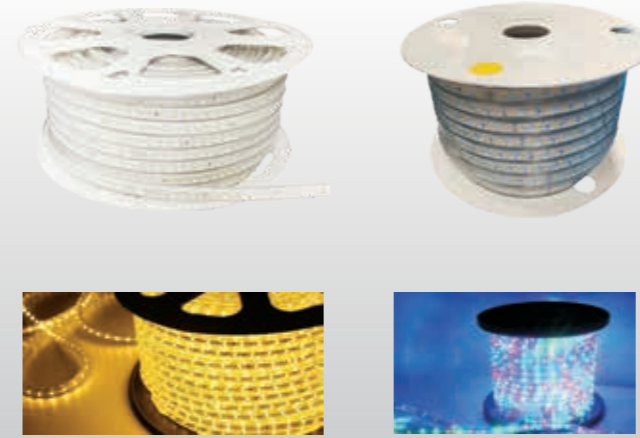

Product Code	Watts/Meter	Voltage	LED'S/Meter	System Luminous Efficacy	CRI	LED Light Source	Beam Angle	CCT	IP Rating	LED Size	STD PKG.
LS02835220V	8W	220V	120	60-70 LM/W	>80	SMD	120°	WH,WW,NW, RD,BL,GR,PK	IP65	2835	50Mtr
LS05050	14.4W	220V	60	60-70 LM/W	>80	SMD	120°	WH,WW, RD,BL,GR	IP65	5050	50Mtr
LS05050	14.4W	220V	60	60-70 LM/W	>80	SMD	120°	RGB,PINK	IP65	5050	50Mtr
LS054	6W	24V	120	60-70 LM/W	>80	SMD	120°	WH,WW	IP65	2835	50Mtr
LS068	12W	24V	120	60-70 LM/W	>80	SMD	120°	WW	IP65	2835	50Mtr

Dimension

PRODUCT CODE	LENGTH	WIDTH	HEIGHT
LS02835220V	50MTR	10.2MM	5.6MM
LS05050	50MTR	20.2MM	5.6MM
LS05050	50MTR	16.8MM	7.15MM
LS054	50MTR	16MM	7MM
LS068	10MTR	9.2MM	4.4MM

Product Features

Rated Life : 30000 Hrs
 Mounting Type : Surface mount
 Housing & Finish : Flexible LED PCB

Applications

Houses, Hotels, Restaurants, Resort, Showrooms

CAPO OUTDOOR LED STRIP- IP65



NERO NEON FLEXIBLE STRIP - OUTDOOR

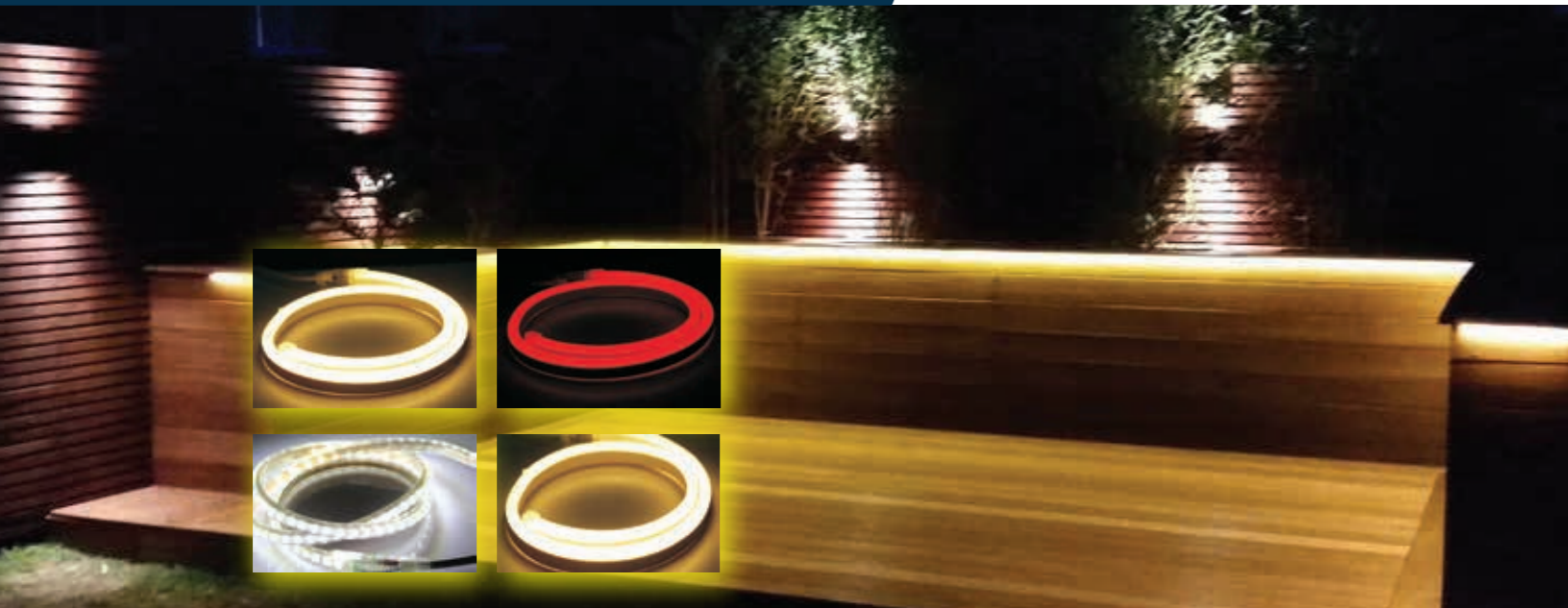

STRIP LIGHT ACCESSORIES



Product Code	Watts/METER	Voltage	LED'S/Meter	System Luminous Efficacy	CRI	LED Light Source	Beam Angle	CCT	IP Rating	LED SIZE	STD PKG
LS02835	12W	220V	120	60-70 LM/W	>80	SMD	120°	WH,WW NW,BL	IP65	2835	50Mtr
LS02835	12W	220V	120	60-70 LM/W	>80	SMD	120°	RD,GR, PINK	IP65	2835	50Mtr
LS0283524V	7W	24V	120	60-70 LM/W	>80	SMD	120°	WW	IP68	2835	50Mtr

Dimension

PRODUCT CODE	LENGTH	WIDTH	HEIGHT
LS02835	50MTR	8MM	14.5MM
LS0283524V	50MTR	6.5MM	13MM

Product Features

Rated Life : 30000 Hrs
 Mounting Type : Surface mount
 Housing & Finish : Flexible LED PCB

Applications

Houses, Hotels, Restaurants, Resort, Showrooms

RGB CONTROLLER

PRODUCT	PRODUCT CODE	COLOR
	LSRGB06	6 AMPS
	LSRGB12	12 AMPS
	LSRGB30	30 AMPS

OUTDOOR STRIP CONNECTOR

PRODUCT	PRODUCT CODE	COLOR
	LSOC5050	WH, WW BLUE
	LSOC5050RGB	RGB

NEON LED STRIP CONNECTOR

PRODUCT	PRODUCT CODE	COLOR
	LSOC2835	ALL COLORS

LSO68 CONNECTOR WITH END CAP

PRODUCT	PRODUCT CODE	COLOR
	LSOC68	WHITE

LSO68 FIXING TAPE

PRODUCT	PRODUCT CODE
	LSOTP68





AMPIO
STRIP DRIVERS

AMPIO STRIP DRIVER



Product Code	Ampere	Input Voltage	Power Factor	Output Voltage	Power	Driver Efficiency	Over Voltage Prot.	Open & Short Circuit Prot.	IP Rating	Surge Voltage	THD
LSD02	2 AMPS	230V	>0.95	12V DC	24W	>87%	YES	YES	IP20	3 KV	<15%
LSD03	3 AMPS	230V	>0.95	12V DC	36W	>87%	YES	YES	IP20	3 KV	<15%
LSD05	5 AMPS	230V	>0.95	12V DC	60W	>87%	YES	YES	IP20	3 KV	<15%
LSD08	8 AMPS	230V	>0.95	12V DC	96W	>87%	YES	YES	IP20	3 KV	<15%
LSD12	12.5 AMPS	230V	>0.95	12V DC	150W	>87%	YES	YES	IP20	3 KV	<15%
LSD16	16 AMPS	230V	>0.95	12V DC	192W	>87%	YES	YES	IP20	3 KV	<15%
LSD20	20 AMPS	230V	>0.95	12V DC	240W	>87%	YES	YES	IP20	3 KV	<15%
LSD30	30 AMPS	230V	>0.95	12V DC	360W	>87%	YES	YES	IP20	3 KV	<15%

Dimension (in mm)

PRODUCT CODE	LENGTH	WIDTH	HEIGHT
LSD02	98	37.56	27.26
LSD03	109	38.1	31.1
LSD05	134.79	40.73	31
LSD08	144.3	46.25	37.47
LSD12	220	52.20	37.6
LSD16	213	64	31
LSD20	213	64	31
LSD30	213	64	31

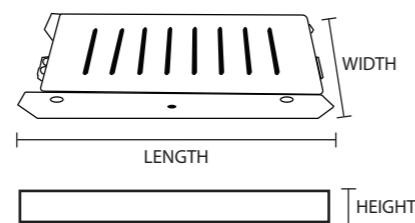

AMPIO OUTDOOR LED STRIP DRIVE

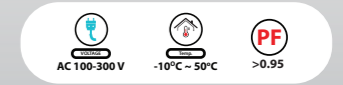

Product Code	Ampere	Input Voltage	Power Factor	Output Voltage	Power	Driver Efficiency	Over Voltage Prot.	Open & Short Circuit Prot.	IP Rating	Surge Voltage	THD
LUWD3	3 AMPS	230V	>0.95	24V DC	72W	>87%	YES	YES	IP65	3 KV	<15%
LUWD5	5 AMPS	230V	>0.95	24V DC	120W	>87%	YES	YES	IP65	3 KV	<15%

Dimension (in mm)

PRODUCT CODE	LENGTH	WIDTH	HEIGHT
LUWD3	101.03	63.38	38.5
LUWD5	116.25	63.85	39.03

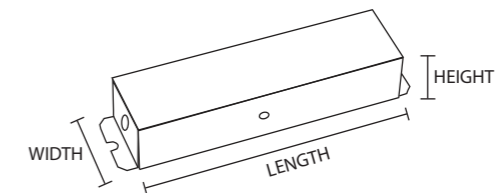



RICO SLEEK CEILING LED

RICO SLEEK CEILING LED

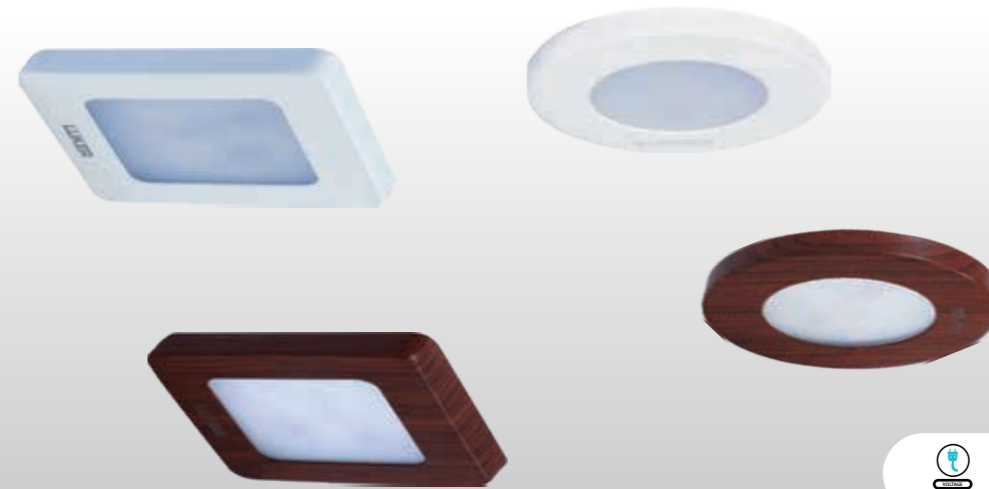

Product Code	Wattage	Voltage	Power Factor	System Luminous Efficacy	CRI	LED Light Source	Beam Angle	CCT	IP Rating	Surge Voltage	Body Finish
LCL03SSQ	3W	230V	>0.95	80 LM/W	>80	SMD	120°	WH,WW	IP20	2 KV	WHITE
LCL03SSW	3W	230V	>0.95	80 LM/W	>80	SMD	120°	WH	IP20	2 KV	WOOD
LCL03SRD	3W	230V	>0.95	80 LM/W	>80	SMD	120°	WH,WW BL,GR,RD,PK	IP20	2 KV	WHITE
LCL03SRW	3W	230V	>0.95	80 LM/W	>80	SMD	120°	WH	IP20	2 KV	WOOD

Dimension (in mm)

PRODUCT CODE	DIA	HEIGHT	PRODUCT CODE	LENGTH	WIDTH	HEIGHT
LCL03SRD	60	10	LCL03SSQ	60	60	10
LCL03SRW	60	10	LCL03SSW	60	60	10

Product Features

- Rated Life : 30000 Hrs
- Mounting Type : Surface Mounted
- Housing & Finish : Die Cast Aluminium + PC Diffuser

Applications

Domestic, Commercial

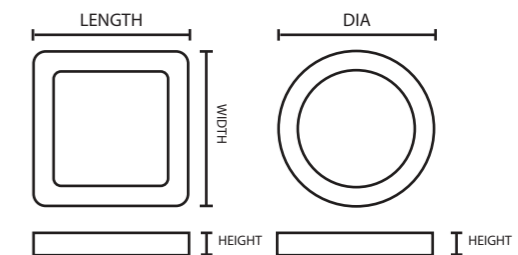



STRADA LED STREET LIGHTS

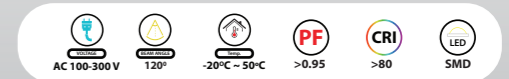

Product Code	Wattage	Voltage	Power Factor	System Luminous Efficacy	CRI	LED Light Source	Beam Angle	CCT	IP Rating	Surge Voltage	THD
LST-15	15W	230V	>0.95	100 LM/W	>80	SMD	120°	WH,WW	IP65	UPTO 20 KV	<5%
LST-24	24W	230V	>0.95	100 LM/W	>80	SMD	120°	WH,WW	IP65	UPTO 20 KV	<5%
LST-36	36W	230V	>0.95	100 LM/W	>80	SMD	120°	WH,WW	IP65	UPTO 20 KV	<5%
LST-48	48W	230V	>0.95	100 LM/W	>80	SMD	120°	WH,WW	IP65	UPTO 20 KV	<5%
LST-60	60W	230V	>0.95	100 LM/W	>80	SMD	120°	WH,WW	IP65	UPTO 20 KV	<5%
LST-72	72W	230V	>0.95	100 LM/W	>80	SMD	120°	WH,WW	IP65	UPTO 20 KV	<5%
LST-90	90W	230V	>0.95	100 LM/W	>80	SMD	120°	WH,WW	IP65	UPTO 20 KV	<5%
LST-120	120W	230V	>0.95	100 LM/W	>80	SMD	120°	WH,WW	IP65	UPTO 20 KV	<5%
LST-160	160W	230V	>0.95	100 LM/W	>80	SMD	120°	WH,WW	IP65	UPTO 20 KV	<5%

Dimension (in mm)

PRODUCT CODE	LENGTH	WIDTH	HEIGHT	PIPE DIA. MAX
LST-15	280	100	60	33
LST-24	323	102	50	33
LST-36	336	119	50	33
LST-48	364	137	56	33
LST-60	364	137	70	33
LST-72	419	195	70	42
LST-90	419	195	70	42
LST-120	419	195	70	42
LST-160	521	250	86	60

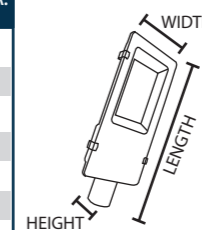

Product Features

- Rated Life : 50000 Hrs
- Mounting Type : Pole Mounted
- Housing & Finish : Die Cast Aluminium + toughned Glass

Applications

Domestic, Commercial, Industries,

STRADA LED STREET LIGHTS



STREET & FLOOD LIGHTS SENSOR TYPE



STRADA SLEEK LED STREET LIGHTS

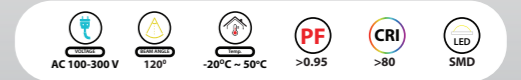

Product Code	Wattage	Voltage	Power Factor	System Luminous Efficacy	CRI	LED Light Source	Beam Angle	CCT	IP Rating	Surge Voltage	THD
LST-24SEN	24W	230V	>0.95	100 LM/W	>80	SMD	120°	WH,WW	IP65	UPTO 20 KV	<5%
LST-48SEN	48W	230V	>0.95	100 LM/W	>80	SMD	120°	WH,WW	IP65	UPTO 20 KV	<5%
LST-72SEN	72W	230V	>0.95	100 LM/W	>80	SMD	120°	WH,WW	IP65	UPTO 20 KV	<5%
LST-120SEN	120W	230V	>0.95	100 LM/W	>80	SMD	120°	WH,WW	IP65	UPTO 20 KV	<5%
LFL50SEN	50W	230V	>0.95	100 LM/W	>80	SMD	120°	WH,WW	IP65	UPTO 20 KV	<5%

Dimension (in mm)

PRODUCT CODE	LENGTH	WIDTH	HEIGHT	PIPE DIA. MAX
LST-24SEN	323	102	50	33
LST-48SEN	364	137	56	33
LST-72SEN	419	195	70	42
LST-120SEN	419	195	70	42
LFL50SEN	247	255	45	-

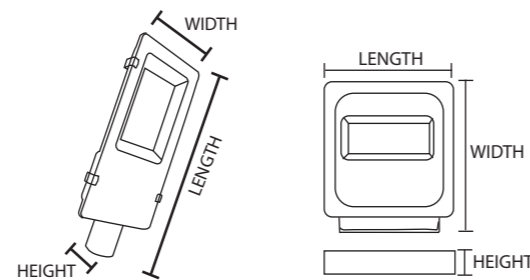

Product Features

- Rated Life : 50000 Hrs
- Mounting Type : Pole Mounted
- Housing & Finish : Die Cast Aluminium + toughned Glass

Applications

Domestic, Commercial, Industries,

Product Code	Wattage	Voltage	Power Factor	System Luminous Efficacy	CRI	LED Light Source	Beam Angle	CCT	IP Rating	Surge Voltage	THD
LSTE-20	20W	230V	>0.95	100 LM/W	>80	SMD	120°	WH	IP65	6 KV	<5%
LSTE-30	30W	230V	>0.95	100 LM/W	>80	SMD	120°	WH	IP65	6 KV	<5%
LSTE-50	50W	230V	>0.95	100 LM/W	>80	SMD	120°	WH	IP65	6 KV	<5%
LSTE-80	80W	230V	>0.95	100 LM/W	>80	SMD	120°	WH	IP65	6 KV	<5%
LSTE-100	100W	230V	>0.95	100 LM/W	>80	SMD	120°	WH	IP65	6 KV	<5%
LSTE-120	120W	230V	>0.95	100 LM/W	>80	SMD	120°	WH	IP65	6 KV	<5%
LSTE-150	150W	230V	>0.95	100 LM/W	>80	SMD	120°	WH	IP65	6 KV	<5%
LSTE-200	200W	230V	>0.95	100 LM/W	>80	SMD	120°	WH	IP65	6 KV	<5%

Dimension (in mm)

PRODUCT CODE	LENGTH	WIDTH	HEIGHT	PIPE DIA. MAX
LSTE-20	260	108	60	42
LSTE-30	310	125	60	45
LSTE-50	365	165	60	45
LSTE-60	375	165	60	42
LSTE-80	375	163	60	42
LSTE-100	432	195	70	48
LSTE-120	432	195	70	48
LSTE-150	630	220	75	60
LSTE-200	450	215	85	60

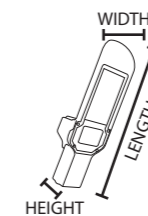

Product Features

- Rated Life : 50000 Hrs
- Mounting Type : Pole Mounted
- Housing & Finish : Die Cast Aluminium + toughned Glass

Applications

Domestic, Commercial, Industries,





LED FLOOD LIGHTS

ALCOR SG LED FLOOD LIGHTS

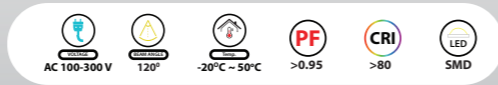

Product Code	Wattage	Voltage	Power Factor	System Luminous Efficacy	CRI	LED Light Source	Beam Angle	CCT	IP Rating	Surge Voltage	THD
LFLSL10SG	10W	230V	>0.95	100 LM/W	>80	SMD	120°	WH,WW	IP66	6 KV	<5%
LFLSL20SG	20W	230V	>0.95	100 LM/W	>80	SMD	120°	WH,WW	IP66	6 KV	<5%
LFLSL30SG	30W	230V	>0.95	100 LM/W	>80	SMD	120°	WH,WW	IP66	6 KV	<5%
LFLSL50SG	50W	230V	>0.95	100 LM/W	>80	SMD	120°	WH,WW	IP66	6 KV	<5%
LFLSL80SG	80W	230V	>0.95	100 LM/W	>80	SMD	120°	WH	IP66	6 KV	<5%
LFLSL100NSG	100W	230V	>0.95	100 LM/W	>80	SMD	120°	WH,WW	IP66	6 KV	<5%

Dimension (in mm)

PRODUCT CODE	LENGTH	WIDTH	HEIGHT
LFLSL10SG	150	120	30
LFLSL20SG	170	140	30
LFLSL30SG	190	160	30
LFLSL50SG	210	180	30
LFLSL80SG	280	240	30
LFLSL100NSG	280	240	30

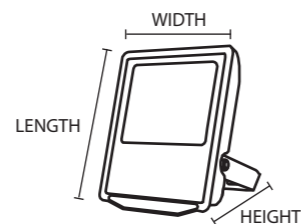

Product Features

Rated Life : 50000 Hrs
 Mounting Type : Wall / Surface Mounted
 Housing & Finish : Die Cast Aluminium + toughned Glass

Applications

Domestic, Commercial, Industries,



ALCOR SG LED FLOOD LIGHTS

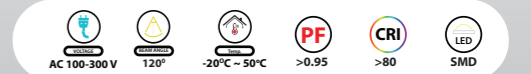

Product Code	Wattage	Voltage	Power Factor	System Luminous Efficacy	CRI	LED Light Source	Beam Angle	CCT	IP Rating	Surge Voltage	THD
LFLSL150NSG	150W	230V	>0.95	100 LM/W	>80	SMD	120°	WH,WW	IP66	6 KV	<5%
LFLSL200NSG	200W	230V	>0.95	100 LM/W	>80	SMD	120°	WH,WW	IP66	6 KV	<5%
LFLSL250NSG	250W	230V	>0.95	100 LM/W	>80	SMD	120°	WH	IP66	6 KV	<5%
LFLSL300NSG	300W	230V	>0.95	100 LM/W	>80	SMD	120°	WH	IP66	6 KV	<5%
LFLSL400NSG	400W	230V	>0.95	100 LM/W	>80	SMD	120°	WH	IP66	6 KV	<5%
LFLSL500	500W	230V	>0.95	100 LM/W	>80	SMD	120°	WH	IP66	6 KV	<5%

Dimension (in mm)

PRODUCT CODE	LENGTH	WIDTH	HEIGHT
LFLSL150NSG	350	270	36
LFLSL200NSG	420	300	36
LFLSL250NSG	480	350	40
LFLSL300NSG	480	350	40
LFLSL400NSG	480	350	40
LFLSL500	515	410	45

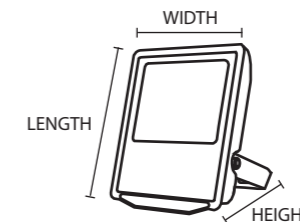

Product Features

Rated Life : 50000 Hrs
 Mounting Type : Wall / Surface Mounted
 Housing & Finish : Die Cast Aluminium + toughned Glass

Applications

Domestic, Commercial, Industries,



ALCOR LN SERIES LED FLOOD LIGHTS

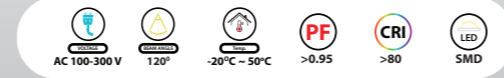

ALCOR LN5Y SERIES LED FLOOD LIGHTS

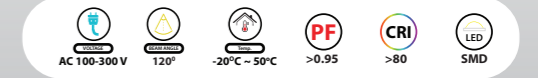

Product Code	Wattage	Voltage	Power Factor	System Luminous Efficacy	CRI	LED Light Source	Beam Angle	CCT	IP Rating	Surge Voltage	THD
LFLN030 GY	30W	230V	>0.95	100 LM/W	>80	SMD	120°	WH,WW	IP65	6 KV	<5%
LFLN050 GY	50W	230V	>0.95	100 LM/W	>80	SMD	120°	WH,WW	IP65	6 KV	<5%
LFLN100 GY	100W	230V	>0.95	100 LM/W	>80	SMD	120°	WH,WW	IP65	6 KV	<5%
LFLN150 GY	150W	230V	>0.95	100 LM/W	>80	SMD	120°	WH,WW	IP65	6 KV	<5%
LFLN160 GY	160W	230V	>0.95	100 LM/W	>80	SMD	120°	WH,WW	IP65	6 KV	<5%
LFLN200 GY	200W	230V	>0.95	100 LM/W	>80	SMD	120°	WH	IP65	6 KV	<5%
LFLN250 GY	250W	230V	>0.95	100 LM/W	>80	SMD	120°	WH,WW	IP65	6 KV	<5%

Dimension (in mm)

PRODUCT CODE	LENGTH	WIDTH	HEIGHT
LFLN030 GY	205	165	55
LFLN050 GY	255	190	55
LFLN100 GY	300	260	55
LFLN150 GY	365	275	75
LFLN160 GY	365	275	75
LFLN200 GY	365	275	75
LFLN250 GY	361	352	65

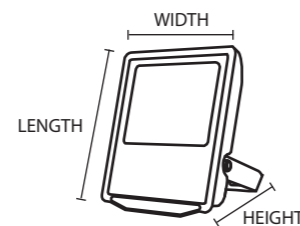

Applications

Domestic, Commercial, Industries,

Product Features

Rated Life : 50000 Hrs
 Mounting Type : Wall / Surface Mounted
 Housing & Finish : Die Cast Aluminium + toughned Glass



Product Code	Wattage	Voltage	Power Factor	System Luminous Efficacy	CRI	LED Light Source	Beam Angle	CCT	IP Rating	Surge Voltage	THD
LFL30LN5Y	30W	230V	>0.95	110 LM/W	>80	SMD	90°	WH,WW	IP65	10 KV	<5%
LFL50LN5Y	50W	230V	>0.95	110 LM/W	>80	SMD	90°	WH,WW	IP65	10 KV	<5%
LFL100LN5Y	100W	230V	>0.95	110 LM/W	>80	SMD	90°	WH,WW	IP65	10 KV	<5%
LFL150LN5Y	150W	230V	>0.95	110 LM/W	>80	SMD	90°	WH,WW	IP65	10 KV	<5%
LFL200LN5Y	200W	230V	>0.95	110 LM/W	>80	SMD	90°	WH,WW	IP65	10 KV	<5%
LFL250LN5Y	250W	230V	>0.95	110 LM/W	>80	SMD	90°	WH,WW	IP65	10 KV	<5%
LFL300LN5Y	300W	230V	>0.95	110 LM/W	>80	SMD	90°	WH,WW	IP65	10 KV	<5%

Dimension (in mm)

PRODUCT CODE	LENGTH	WIDTH	HEIGHT
LFL30LN5Y	362	296	72
LFL50LN5Y	455	340	74
LFL100LN5Y	290	240	57
LFL150LN5Y	362	296	72
LFL200LN5Y	489	338	74
LFL250LN5Y	489	338	74
LFL300LN5Y	385	300	110

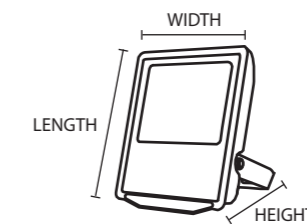

Applications

Domestic, Commercial, Industries,

Product Features

Rated Life : 50000 Hrs
 Mounting Type : Wall / Surface Mounted
 Housing & Finish : Die Cast Aluminium + toughned Glass





LED FLOOD LIGHTS

ENDEAVOUR LED FLOOD LIGHTS

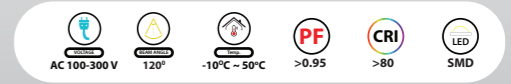

Product Code	Wattage	Voltage	Power Factor	System Luminous Efficacy	CRI	LED Light Source	Beam Angle	CCT	IP Rating	Surge Voltage	THD
LFLHL150	150W	230V	>0.95	100 LM/W	>80	SMD	120°	WH	IP65	6 KV	<5%
LFLHL200	200W	230V	>0.95	100 LM/W	>80	SMD	120°	WH	IP65	6 KV	<5%
LFLHL300	300W	230V	>0.95	100 LM/W	>80	SMD	120°	WH	IP65	6 KV	<5%
LFLHL350	350W	230V	>0.95	100 LM/W	>80	SMD	120°	WH	IP65	6 KV	<5%

Dimension (in mm)

PRODUCT CODE	LENGTH	WIDTH	HEIGHT
LFLHL150	370	355	65
LFLHL200	450	355	65
LFLHL300	610	355	65
LFLHL350	685	355	65

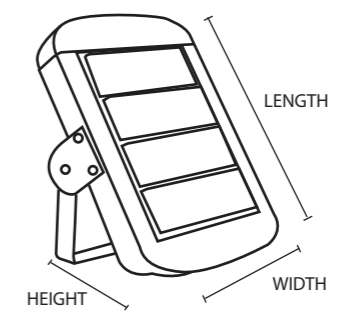

Product Features

- Rated Life : 50000 Hrs
- Mounting Type : Wall / Surface Mounted
- Housing & Finish : Die Cast Aluminium + toughned Glass

Applications

Domestic, Commercial, Industries,





NELLA IP65 LED TUNNEL LIGHTS

NELLA IP65 LED TUNNEL LIGHTS



Product Code	Wattage	Voltage	Power Factor	System Luminous Efficacy	CRI	LED Light Source	Beam Angle	CCT	IP Rating	Surge Voltage	THD
LFLHL30	30W	230V	>0.95	100 LM/W	>80	SMD	120°	WH	IP65	6 KV	<10%
LFLHL50	50W	230V	>0.95	100 LM/W	>80	SMD	120°	WH	IP65	6 KV	<10%

Dimension (in mm)

PRODUCT CODE	LENGTH	WIDTH	HEIGHT (Incl.Clamp)
LFLHL30	300	70	220
LFLHL50	300	70	220

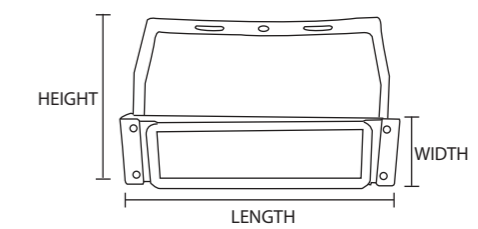

Product Features

- Rated Life : 50000 Hrs
- Mounting Type : Wall / Surface Mounted
- Housing & Finish : Die Cast Aluminium + toughned Glass

Applications

Domestic, Commercial, Industries,





**WELL GLASS &
CANOPY LIGHTS**

FARO WELL GLASS LED LIGHTS



CENNO CANOPY LED LIGHTS



Product Code	Wattage	Voltage	Power Factor	System Luminous Efficacy	CRI	LED Light Source	Beam Angle	CCT	IP Rating	Surge Voltage	THD
2 YEARS WARRANTY											
LW040	40W	230V	>0.95	100 LM/W	>80	SMD	120°	WH	IP65	6 KV	<5%
LW040	40W	230V	>0.95	100 LM/W	>80	SMD	120°	WH	IP65	6 KV	<5%
5 YEARS WARRANTY											
LW070	70W	230V	>0.95	100 LM/W	>80	SMD	120°	WH	IP65	6 KV	<5%
LW040	40W	230V	>0.95	100 LM/W	>80	SMD	120°	WH	IP65	6 KV	<5%

Dimension (in mm)

2 YEARS WARRANTY		
PRODUCT CODE	DIA	HEIGHT
LW040	145	125
LW070	180	160

5 YEARS WARRANTY		
PRODUCT CODE	DIA	HEIGHT
LW040	160	155
LW070	205	190

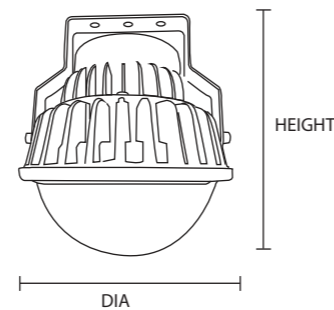

Product Features

Rated Life : 50000 Hrs
 Mounting Type : Wall / Surface Mounted
 Housing & Finish : Die Cast Aluminium + toughened Glass

Applications

Domestic, Commercial, Industries,

Product Code	Wattage	Voltage	Power Factor	System Luminous Efficacy	CRI	LED Light Source	Beam Angle	CCT	IP Rating	Surge Voltage	THD
LPB080	80W	230V	>0.95	100 LM/W	>80	SMD	120°	WH	IP65	6 KV	<5%
LPB080N	80W	230V	>0.95	100 LM/W	>80	SMD	120°	WH	IP65	6 KV	<5%

Dimension (in mm)

PRODUCT CODE	LENGTH	WIDTH	HEIGHT
LPB080	325	325	80
LPB080N	375	375	180

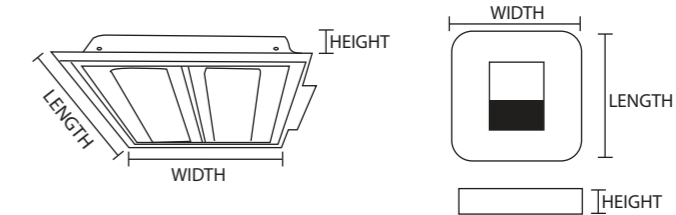

Product Features

Rated Life : 50000 Hrs
 Mounting Type : Recess Mounted
 Housing & Finish : Die Cast Aluminium + PC Diffuser

Applications

Commercial, Industrial,





ARCO WALL WASHER LED LIGHTS

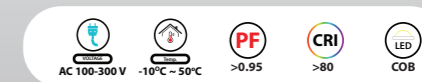

Product Code	Wattage	Voltage	Power Factor	System Luminous Efficacy	CRI	LED Light Source	Beam Angle	CCT	IP Rating	Surge Voltage	THD
LODWW10R	10W	230V	>0.95	100 LM/W	>80	COB	10°	WH,WW BL,GR,GDY	IP65	3 KV	<15%
LODWW18R	18W	230V	>0.95	100 LM/W	>80	COB	10°	WH,BL GDY	IP65	3 KV	<15%
LODWW18SQ	18W	230V	>0.95	100 LM/W	>80	COB	10°	WH,BL GDY	IP65	3 KV	<15%
LODWW12	12W	230V	>0.95	100 LM/W	>80	COB	30°	BL	IP65	3 KV	<15%
LODWW24	24W	230V	>0.95	100 LM/W	>80	COB	30°	BL	IP65	3 KV	<15%
LODWW36	36W	230V	>0.95	100 LM/W	>80	COB	30°	BL	IP65	3 KV	<15%

Dimension (in mm)

PRODUCT CODE	LENGTH	WIDTH	HEIGHT
LODWW10R	150	70	-
LODWW18R	150	70	154
LODWW18SQ	149	88.5	154
LODWW12	500	60	60
LODWW24	1000	60	60
LODWW36	1000	48	30

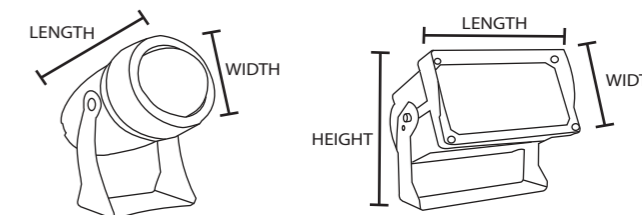

Product Features

- Rated Life : 30000 Hrs
- Mounting Type : Surface Mounted
- Housing & Finish : Die Cast Aluminium + Glass

Applications

Domestic, Commercial, Exterior Lighting

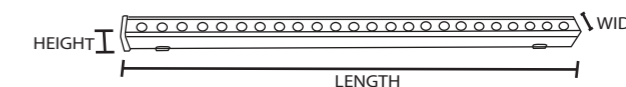

WALL WASHER LED LIGHTS





HIGH BAY LIGHTS

AVIOR LOW BAY & HIGH BAY LED

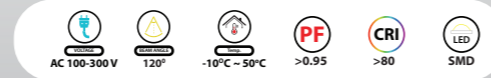

Product Code	Wattage	Voltage	Power Factor	System Luminous Efficacy	CRI	LED Light Source	Beam Angle	CCT	IP Rating	Surge Voltage	THD
LHBYC40	40W	230V	>0.95	100 LM/W	>80	SMD	120°	WH	IP40	10 KV	<5%
LHBY50	50W	230V	>0.95	100 LM/W	>80	SMD	120°	WH	IP40	10 KV	<5%
LHBY70	70W	230V	>0.95	100 LM/W	>80	SMD	120°	WH	IP40	10 KV	<5%
LHBY100	100W	230V	>0.95	100 LM/W	>80	SMD	120°	WH	IP40	10 KV	<5%
LHBY120	1200W	230V	>0.95	100 LM/W	>80	SMD	120°	WH	IP40	10 KV	<5%
LHBY150	150W	230V	>0.95	100 LM/W	>80	SMD	120°	WH	IP40	10 KV	<5%
LHBY200	200W	230V	>0.95	100 LM/W	>80	SMD	120°	WH	IP40	10 KV	<5%

Dimension (in mm)

PRODUCT CODE	DIA	HEIGHT
LHBYC40	350	210
LHBY50	350	285
LHBY70	350	285
LHBY100	500	260
LHBY120	500	270
LHBY150	500	270
LHBY200	500	270



Product Features

Rated Life : 50000 Hrs
 Mounting Type : Suspended Mount
 Housing & Finish : Die Cast Alu. Body + Clear Anodised Alu. Diffuser

Applications

Industries, Warehouse, Commercial



AVIOR LENS TYPE HIGH BAY LED

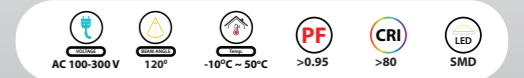

Product Code	Wattage	Voltage	Power Factor	System Luminous Efficacy	CRI	LED Light Source	Beam Angle	CCT	IP Rating	Surge Voltage	THD
LOHY50	50W	230V	>0.95	100 LM/W	>80	SMD	120°	WH	IP65	10 KV	<5%
LOHY100	100W	230V	>0.95	100 LM/W	>80	SMD	120°	WH	IP65	10 KV	<5%
LOHY150	150W	230V	>0.95	100 LM/W	>80	SMD	120°	WH	IP65	10 KV	<5%
LOHY200	200W	230V	>0.95	100 LM/W	>80	SMD	120°	WH	IP65	10 KV	<5%
LOHY250	250W	230V	>0.95	100 LM/W	>80	SMD	120°	WH	IP65	10 KV	<5%
LHBY150HL	150W	230V	>0.95	100 LM/W	>80	SMD	120°	WH	IP65	10 KV	<5%

Dimension (in mm)

PRODUCT CODE	DIA	HEIGHT
LOHY50	245	135
LOHY100	362	141
LOHY150	320	138
LOHY200	360	138
LOHY250	360	138

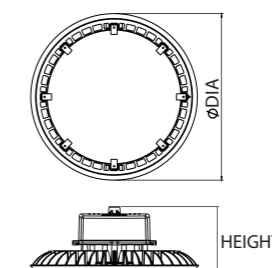

PRODUCT CODE	LENGTH	WIDTH	HEIGHT
LHBY150HL	965	90	60

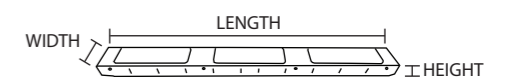

Product Features

Rated Life : 50000 Hrs
 Mounting Type : Suspended Mount
 Housing & Finish : Die Cast Aluminium + toughned Glass

Applications

Industries, Warehouse, Commercial



AVIOR REFLECTOR TYPE HIGH BAY LED

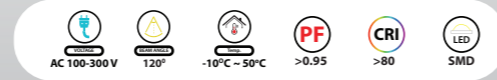
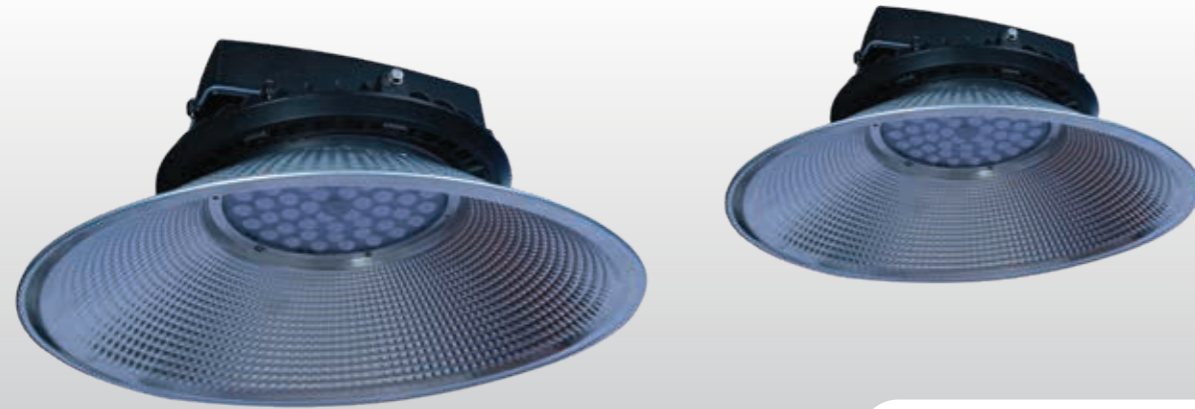

Product Code	Wattage	Voltage	Power Factor	System Luminous Efficacy	CRI	LED Light Source	Beam Angle	CCT	IP Rating	Surge Voltage	THD
LOHY50	50W	230V	>0.95	100 LM/W	>80	SMD	120°	WH	IP65	10 KV	<5%
LOHY100	100W	230V	>0.95	100 LM/W	>80	SMD	120°	WH	IP65	10 KV	<5%
LOHY150	150W	230V	>0.95	100 LM/W	>80	SMD	120°	WH	IP65	10 KV	<5%
LOHY200	200W	230V	>0.95	100 LM/W	>80	SMD	120°	WH	IP65	10 KV	<5%
LOHY250	250W	230V	>0.95	100 LM/W	>80	SMD	120°	WH	IP65	10 KV	<5%

Dimension (in mm)

PRODUCT CODE	DIA	HEIGHT
LOHY50	245	135
LOHY100	362	141
LOHY150	320	138
LOHY200	360	138
LOHY250	360	138

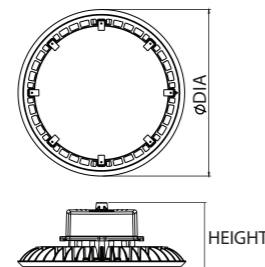

REFELETOR DIMENSION (In mm)

ALL WATTAGE	OUTER DIA	HEIGHT
	500	120

Product Features

- Rated Life : 50000 Hrs
- Mounting Type : Suspended Mount
- Housing & Finish : Die Cast Aluminium + toughned Glass

Applications

Industries, Warehouse, Commercial



AVIOR HIGH BAY LED - 5 YEAR WARRANTY



Product Code	Wattage	Voltage	Power Factor	System Luminous Efficacy	CRI	LED Light Source	Beam Angle	CCT	IP Rating	Surge Voltage	THD
LOHY50	50W	230V	>0.95	100 LM/W	>80	SMD	120°	WH	IP65	10 KV	<5%
LOHY100	100W	230V	>0.95	100 LM/W	>80	SMD	120°	WH	IP65	10 KV	<5%
LOHY150	150W	230V	>0.95	100 LM/W	>80	SMD	120°	WH	IP65	10 KV	<5%
LOHY200	200W	230V	>0.95	100 LM/W	>80	SMD	120°	WH	IP65	10 KV	<5%
LHBY250	250W	230V	>0.95	100 LM/W	>80	SMD	120°	WH	IP65	10 KV	<5%

Dimension (in mm)

PRODUCT CODE	DIA	HEIGHT
LOHY50	245	135
LOHY100	362	141
LOHY150	320	138
LOHY200	360	138
LOHY250	360	138

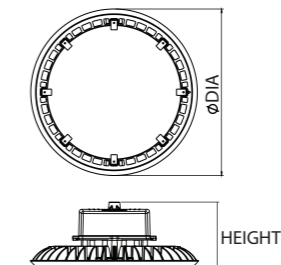

Product Features

- Rated Life : 50000 Hrs
- Mounting Type : Suspended Mount
- Housing & Finish : Die Cast Aluminium + toughned Glass

Applications

Industries, Warehouse, Commercial





LINEAR LED LIGHTING

LUSSO LINEAR LIGHTING (ASSEMBLED)



Product Code	Wattage	Voltage	Power Factor	System Luminous Efficacy	CRI	LED Light Source	Beam Angle	CCT	IP Rating	Surge Voltage	THD
LPL70501M	43W	230V	>0.95	80 LM/W	>80	SMD	120°	WH,WW NW	IP20	3 KV	<15%
LPL70502M	86W	230V	>0.95	80 LM/W	>80	SMD	120°	WH,WW NW	IP20	3 KV	<15%

Dimension (in mm)

PRODUCT CODE	LENGTH	WIDTH	HEIGHT
LPL70501M	1219	50	70
LPL70502M	2438	50	70

Product Features

Rated Life : 50000 Hrs
 Mounting Type : Suspended Mount
 Housing & Finish : Die Cast Aluminium + PC Diffuser

Applications

Houses, Offices, Hospitals, Showrooms, Hotels,



LUSSO LINEAR LIGHTING (ASSEMBLED)

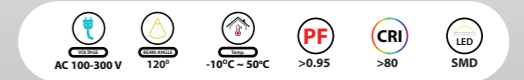

Product Code	Wattage	Voltage	Power Factor	System Luminous Efficacy	CRI	LED Light Source	Beam Angle	CCT	IP Rating	Surge Voltage	THD
LPL50351M	36W	230V	>0.95	70 LM/W	>80	SMD	120°	WH,WW NW	IP20	3 KV	<15%
LPL50352M	72W	230V	>0.95	70 LM/W	>80	SMD	120°	WH,WW NW	IP20	3 KV	<15%

Dimension (in mm)

PRODUCT CODE	LENGTH	WIDTH	HEIGHT
LPL50351M	1000	50	35
LPL50352M	2000	50	35

Product Features

Rated Life : 50000 Hrs
 Mounting Type : Suspended Mount
 Housing & Finish : Die Cast Aluminium + PC Diffuser

Applications

Houses, Offices, Hospitals, Showrooms, Hotels,



LUSSO LED LINEAR LIGHTING



Product Code : LPL1413
 Mount type : Concealed
 Body Material : Alu + PC Diffuser
 Body Color : Aluminium Finish
 IP Rating : IP20
 Standard Length : 2 Meter
 Accessory : 2 End Caps & 3 Clamps

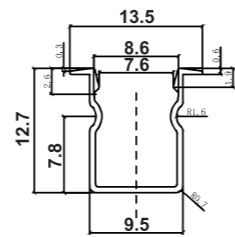

Product Code : LPL2514
 Mount type : Concealed
 Body Material : Alu + PC Diffuser
 Body Color : Aluminium Finish
 IP Rating : IP20
 Standard Length : 2 Meter
 Accessory : 2 End Caps & 3 Clamps

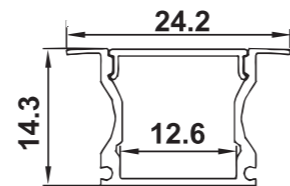

Product Code : LPL2514 BK
 Mount type : Concealed
 Body Material : Alu + PC Diffuser
 Body Color : Black Finish
 IP Rating : IP20
 Standard Length : 2 Meter
 Accessory : 2 End Caps & 3 Clamps

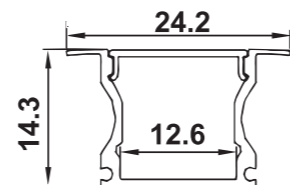

LUSSO LED LINEAR LIGHTING



Product Code : LPL1809
 Mount type : Concealed
 Body Material : Alu + PC Diffuser
 Body Color : Aluminium Finish
 IP Rating : IP20
 Standard Length : 2 Meter
 Accessory : 2 End Caps & 3 Clamps

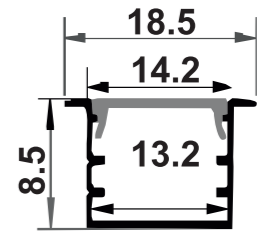

Product Code : LPL1010
 Mount type : Concealed
 Body Material : Alu + PC Diffuser
 Body Color : Aluminium Finish
 IP Rating : IP20
 Standard Length : 2 Meter
 Accessory : 2 End Caps & 3 Clamps

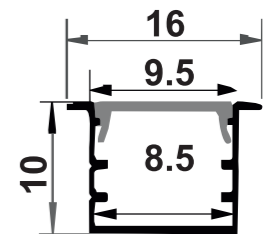

Product Code : LPL4026
 Mount type : Concealed
 Body Material : Alu + PC Diffuser
 Body Color : Aluminium Finish
 IP Rating : IP20
 Standard Length : 2 Meter
 Accessory : 2 End Caps & 3 Clamps

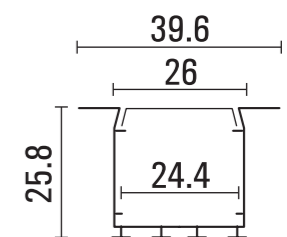

Product Code : LPL5035
 Mount type : Concealed
 Body Material : Alu + PC Diffuser
 Body Color : White Powder Coated
 IP Rating : IP20
 Standard Length : 2 Meter
 Accessory : 2 End Caps & 3 Clamps

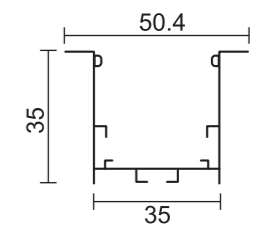

ALCUNO LED LINEAR LIGHTING COMPONENTS



Product Code : LPL7050
 Mount type : Surface
 Body Material : Alu + PC Diffuser
 Body Color : White Powder Coated
 IP Rating : IP20
 Standard Length : 2 Meter / 2.5 Meter
 Accessory : 2 End Caps & 3 Clamps

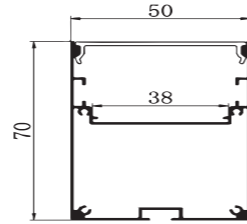

Product Code : LPL7050 BK
 Mount type : Surface
 Body Material : Alu + PC Diffuser
 Body Color : Black Finish
 IP Rating : IP20
 Standard Length : 2 Meter / 2.5 Meter
 Accessory : 2 End Caps & 3 Clamps

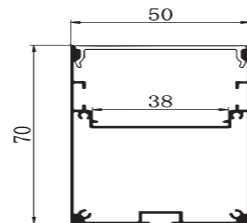

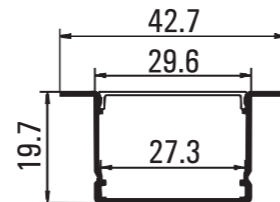

Product Code : LPL4320 BK
 Mount type : Concealed
 Body Material : Alu + PC Diffuser
 Body Color : Black Finish
 IP Rating : IP20
 Standard Length : 2 Meter
 Accessory : 2 End Caps & 3 Clamps



LUSSO LED LINEAR LIGHTING

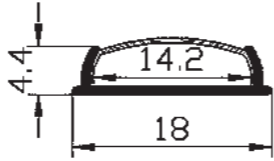

	Product Code : LPL1805	
	Mount type : Surface Body Material : Alu + PC Diffuser Body Color : Aluminium Finish IP Rating : IP20 Standard Length : 2 Meter Accessory : 2 End Caps & 3 Clamps	

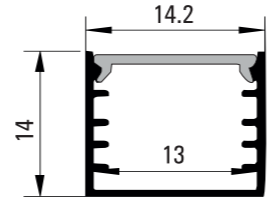
	Product Code : LPL1414	
	Mount type : Surface Body Material : Alu + PC Diffuser Body Color : Aluminium Finish IP Rating : IP20 Standard Length : 2 Meter Accessory : 2 End Caps & 3 Clamps	

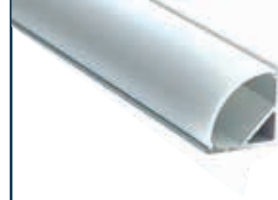
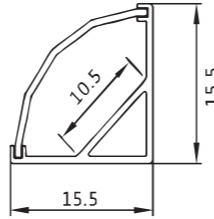
	Product Code : LPL2115	
	Mount type : Corner Surface Body Material : Alu + PC Diffuser Body Color : Aluminium Finish IP Rating : IP20 Standard Length : 2 Meter Accessory : 2 End Caps & 3 Clamps	

LUSSO LED LINEAR LIGHTING

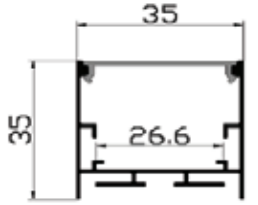

	Product Code : LPL3535	
	Mount type : Surface Body Material : Alu + PC Diffuser Body Color : White Powder Coated IP Rating : IP20 Standard Length : 2 Meter Accessory : 2 End Caps & 3 Clamps	

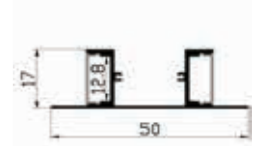
	Product Code : LPL5015	
	Mount type : Surface Body Material : Alu + PC Diffuser Body Color : White Powder Coated IP Rating : IP20 Standard Length : 2 Meter Accessory : 2 End Caps & 3 Clamps	

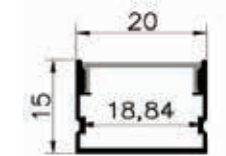
	Product Code : LPL2015	
	Mount type : Surface Body Material : Alu + PC Diffuser Body Color : Aluminium Finish IP Rating : IP20 Standard Length : 2 Meter Accessory : 2 End Caps & 3 Clamps	

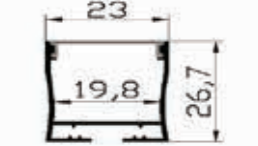
	Product Code : LPL2025	
	Mount type : Surface Body Material : Alu + PC Diffuser Body Color : White Powder Coated IP Rating : IP20 Standard Length : 2 Meter Accessory : 2 End Caps & 3 Clamps	

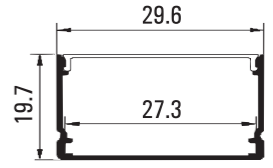
	Product Code : LPL3020 BK	
	Mount type : Surface Body Material : Alu + PC Diffuser Body Color : Black Finish IP Rating : IP20 Standard Length : 2 Meter Accessory : 2 End Caps & 3 Clamps	



ALCUNO LED LINEAR LIGHTING STRIP

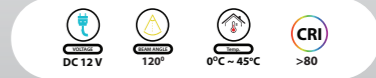
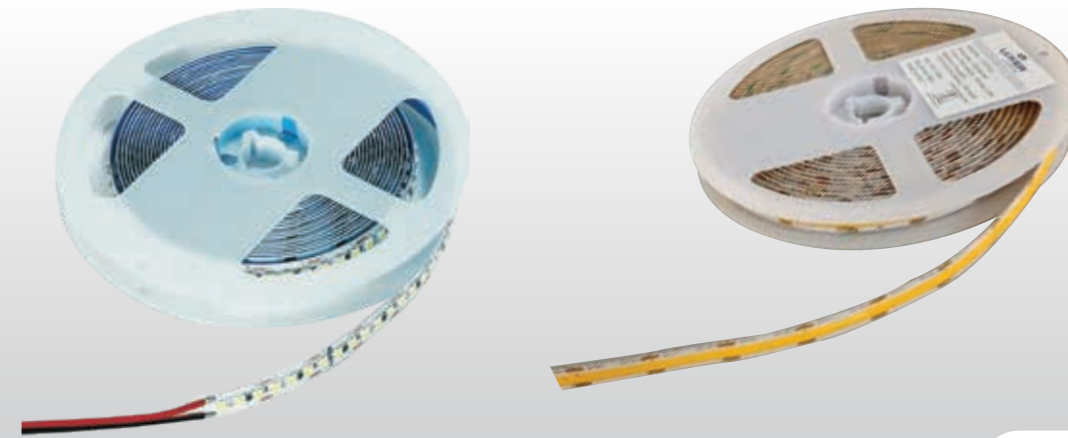

Product Code	Wattage	Voltage	LED's/ Meter	System Luminous Efficacy	CRI	LED Light Source	Beam Angle	CCT	IP Rating	LED Size	STD PKG.
LPLS120	12W	12V DC	120	60-70 LM/W	>80	SMD	120°	WH,WW NW,BL	IP20	2835	5 MTR
LPLS180	18W	12V DC	180	60-70 LM/W	>80	SMD	120°	WH,WW NW,BL	IP20	2835	5 MTR
LPLS240	20W	12V DC	240	60-70 LM/W	>80	SMD	120°	WH,WW NW	IP20	2835	5 MTR
LSCOB384	12W	12V DC	384	60-70 LM/W	>80	COB	120°	WW	IP20	-	5 MTR

Dimension (in mm)

PRODUCT CODE	LENGTH	WIDTH	HEIGHT
LPLS120	5000	7.9	1.40
LPLS180	5000	9.84	1.33
LPLS240	5000	9.9	1.40
LSCOB384	5000	10.1	1.8

Product Features

Rated Life : 30000 Hrs
 Mounting Type : Surface mount
 Housing & Finish : Flexible LED PCB

Applications

Houses, Hotels, Restaurants, Resort, Showrooms



ALCUNO ACCESSORIES



HANGING KIT - 1 MTR



MODEL	QUANTITY	BODY COLOR
LPLSHK	1 PAIR	CHROME

HANGING KIT - 2 MTR



MODEL	QUANTITY	BODY COLOR
LPLDHK	1 PAIR	CHROME

STRAIGHT CONNECTOR



MODEL	SUITABLE FOR	BODY COLOR
LPLSTCN	LPL3535, LPL4435, LPL5035	CHROME

45° SIDE ANGLE CONNECTOR



MODEL	SUITABLE FOR	BODY COLOR
LPL45INCN	LPL3535, LPL4435, LPL5035	CHROME

45° TOP ANGLE CONNECTOR



MODEL	SUITABLE FOR	BODY COLOR
LPL45EXCN	LPL3535, LPL4435, LPL5035	CHROME

SURFACE MOUNTING CLIPS



MODEL	SUITABLE FOR	BODY COLOR
LPLCL01	LPL2514, LPL0192, LPL2967	CHROME

RECESS MOUNTING SPRING CLIPS



MODEL	SUITABLE FOR	BODY COLOR
LPLCL02	LPL4435, LPL2319	CHROME

ALCUNO
ACCESSORIES



EMERGENCY LIGHTS



Product Code	Wattage	Voltage	Power Factor	System Luminous Efficacy	CRI	LED Light Source	Beam Angle	CCT	IP Rating	Surge Voltage	THD
FOCO EMERGENCY BULB											
LBGB09CL	9W	230V	>0.95	100 LM/W	>80	SMD	120°	WH	IP40	3 KV	<15%
LBGB12CL	12W	230V	>0.95	100 LM/W	>80	SMD	120°	WH	IP40	3 KV	<15%
LUMOS EMERGENCY TUBE											
LTGT520	20W	230V	>0.95	100 LM/W	>80	SMD	120°	WH	IP40	3 KV	<15%
IRIS EMERGENCY PANEL											
LNSPELRDE0015	11x18W	230V	>0.95	100 LM/W	>80	SMD	120°	WH	IP40	3 KV	<15%

Dimension (in mm)

PRODUCT CODE	LENGTH	WIDTH	HEIGHT	PRODUCT CODE	DIA	HEIGHT	CUT-OUT
LTGT520	1190	20	30	LNSPELRDE0015	170	20	155
PRODUCT CODE	DIA	HEIGHT					
LBGB09CL	70	145					
LBGB12CL	80	155					

MODE OF OPERATION

Normal AC Mode: Connect the pannel into the AC supply, it will Turn on and charge the battery at the same time.

Emergency Mode: When power failure, the light will glow automatically and the light will last upto 2 hours if it is fully charged.

EMERGENCY LIGHTS



VICINO SMART BACKLIT PANEL

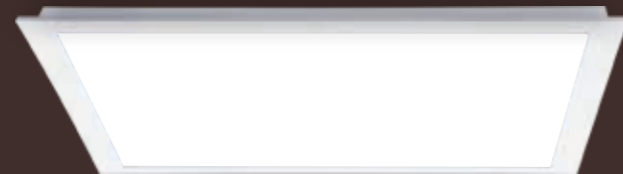
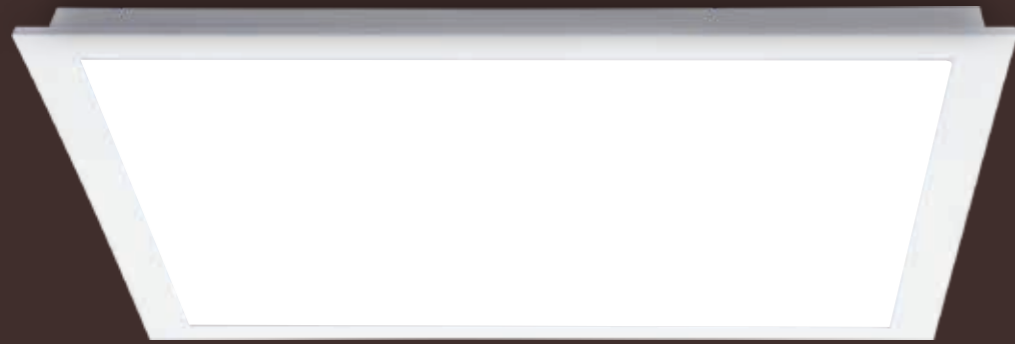

IS 10222(Part 1)Sec 1:2012
R44200015
www.luker.com

VICINO SMART BACKLIT PANEL

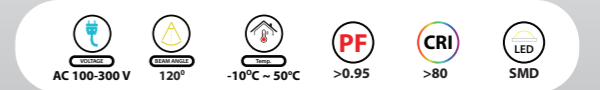

Product Code	Wattage	Voltage	Power Factor	System Luminous Efficacy	CRI	LED Light Source	Beam Angle	CCT	IP Rating	Surge Voltage	THD
LKM2240 SMA	40W	230V	>0.95	100 LM/W	>80	SMD	120°	2700K-6500K	IP20	4 KV	<10%

Dimension (in mm)

PRODUCT CODE	LENGTH	WIDTH	HEIGHT	CUTOUT
LKM2240 SMA	595	595	35	570X570

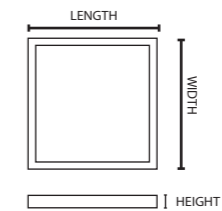

Product Features

- Rated Life : 50000 Hrs
- Mounting Type : Recess Mounted
- Housing & Finish : Die Cast Aluminium + PC Diffuser

Applications

Houses, Offices, Hospitals, Showrooms

Smart Panel Features

- Light CCT tunable from 2700K - 6500K
- Dimmable smoothly from 100% - 10%
- Group Control function available to operate Multiple devices together
- Customised Off-Timer Function available

Download TUYA SMART LIFE / SMART LIFE app on Play Store & App Store

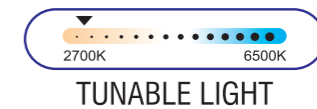



SOLTERO COMMERCIAL LED SOLAR STREET LIGHT



SOLTERO COMMERCIAL LED SOLAR STREET LIGHT



Product Code	LSTPSOL012	LSTPSOL018	LSTPSOL040
Wattage	12W	18W	40W
System Luminous Flux	1200 LM	1800 LM	4000 LM
Beam Angle	120°	120°	120°
CCT	6000-6500K	6000-6500K	6000-6500K
Battery Type	LifepO4,12.8V 6AH	LifepO4,12.8V 12AH	LifepO4,12.8V 24AH
Charging Time(by Sun)	7-8 Hrs	7-8 Hrs	7-8 Hrs
Backup Time	8-12 Hrs	8-12 Hrs	8-12 Hrs
Detection Range	12m Height With 75° Sensing Area	12m Height With 75° Sensing Area	12m Height With 75° Sensing Area
IP Rating	IP65	IP65	IP65
Solar Panel	18V 40W, POLYCRYSTALLINE	18V 50W, POLYCRYSTALLINE	18V 100W, POLYCRYSTALLINE
Sensor Available	PIR + Ambient Light Sensor	PIR + Ambient Light Sensor	PIR + Ambient Light Sensor
Dimension	L:325MM, W:150MM, H:65MM	L:325MM, W:150MM, H:65MM	L:522MM, W:180MM, H:80MM
Pipe Dia	INSTALL Ø42MM	INSTALL Ø42MM	INSTALL Ø42MM
Solar Panel Dimension	665MM X 425MM X 32MM	L:665MM, W:550MM, H:32MM	L:1010MM W:665MM H:32MM
Preferred Mounting Height	4 TO 5 MTR	4 TO 5 MTR	5 TO 6 MTR
Rated Life	> 50,000 HOURS	> 50,000 HOURS	> 50,000 HOURS
Luminaire Body & Finish	DIE CAST ALUMINIUM BODY	DIE CAST ALUMINIUM BODY	DIE CAST ALUMINIUM BODY

- Solar streetlights will turn ON automatically in the absence of sunlight.
- Also it has Built-in PIR sensor for controlling the brightness. First 4 hours it glows with 100% brightness and thereafter goes into power saving mode-with 30% brightness.
- In power saving mode it will glow at 100% brightness (30 sec only) if any movement is detected within 12 meter radius.





SOLTERO DOMESTIC LED SOLAR STREET LIGHT

SOLTERO DOMESTIC LED SOLAR STREET LIGHT



Product Code	LSTSOL10N	LSTSOL18N	LSTSOL24N	LSTSOL30N
Wattage	10W	18W	24W	30W
System Luminous Flux	120 LM	120 LM	120 LM	120 LM
Beam Angle	85X140°	85X140°	85X140°	85X140°
CCT	WH	WH	WH	WH
Battery Type	LifepO4,12.8V 6AH	LifepO4,12.8V 12AH	LifepO4,12.8V 24AH	LifepO4,12.8V 24AH
Charging Time(by Sun)	6-8 Hrs	6-8 Hrs	6-8 Hrs	6-8 Hrs
Backup Time	8-12 Hrs	8-12 Hrs	8-12 Hrs	8-12 Hrs
Detection Range	8-10m Height With 120° Sensing Area	8-10m Height With 120° Sensing Area	8-10m Height With 120° Sensing Area	8-10m Height With 120° Sensing Area
IP Rating	IP66	IP66	IP66	IP66
Solar Panel	6V/7W, MONOCRYSTALLINE	6V/10W, MONOCRYSTALLINE	6V/14W, MONOCRYSTALLINE	10V/20W, MONOCRYSTALLINE
Sensor Available	PIR + Ambient Light Sensor	PIR + Ambient Light Sensor	PIR + Ambient Light Sensor	PIR + Ambient Light Sensor
Dimesnion	L:360MM, W:185MM, H:57MM	L:465MM, W:190MM, H:57MM	L:595MM, W:195MM, H:57MM	L:630MM, W:250MM, H:65MM
Pipe Dia	INSTALL Ø45MM	INSTALL Ø45MM	INSTALL Ø45MM	INSTALL Ø45MM
Prefferred Mounting Height	4 TO 5 MTR	4 TO 5 MTR	5 TO 6 MTR	5 TO 6 MTR
Rated Life	> 30,000 HOURS	> 30,000 HOURS	> 30,000 HOURS	> 30,000 HOURS
Luminaire Body & Finish	ABS BODY	ABS BODY	ABS BODY	ABS BODY

- Solar streetlights will turn ON automatically in the absence of sunlight.
- Also it has Built-in PIR sensor for controlling the brightness.
- In power saving mode it will glow at 100% brightness (30 sec only) if any movement is detected within 12 meter radius.

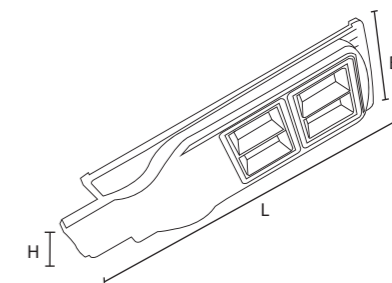

LED

Light-emitting diode (LED) is a semiconductor device that emits light when an electric current is passed through it

CORRELATED COLOR TEMPERATURE (CCT)

This is a measurement of the Yellowness or Blueness of a White light source based on a Kelvin number. Yellowish White described as Warm White is comparable to Incandescent Lamps which have a lower Kelvin temperature number around 2700-3000 range. White and Bluish White described as Natural White and Cold White have a higher Kelvin Temperature of 5000-7000.

BeamAngle

Also known as beam spread, the beam angle is a value that describes the downward light cone emitted by a lighting fixture with a reflector. The beam angle is measured between the downward direction, where the lamp provides maximum lighting intensity, and the direction in which intensity drops to 50%.

Color Rendering Index (CRI)

A metric used to describe how faithfully a light source can render the true colors of objects and spaces, where natural light sources like the sun have a perfect index of 100. Using lamps with a high CRI value is very important in high-end interior design, as they enhance the visibility of décor and fine details.

Diffuser

A piece of glass or acrylic that has the purpose of scattering the light from a bulb, which results makes lighting more uniform and eliminates glare.

Efficacy. Describes how effectively a lighting fixture can convert electric power into lighting, measured in lumens per watt.

Heat sink

A lamp or luminaire component that is used to dissipate heat effectively. Heat sinks normally use materials with a high thermal conductivity and have a fin-like geometry so that their surface area in contact with the air is maximized.

Ingress Protection (IP) Rating. Ingress Protection rating, a two-digit code that indicates the resistance of a lighting fixture to solid particles and liquids, where higher digits indicate enhanced protection. The first digit indicates protection against solids, and the second indicates the protection degree against liquids.

Kelvin (K)

Measurement unit for temperature, although in the lighting industry it is more commonly used to indicate the correlated color temperature (CCT) of light sources.

Lens

Lamp or luminaire component that has the goal of dispersing the lighting output so that the desired distribution pattern is achieved.

LM-79

IESNA standard that establishes the procedure to test the photometric and electrical properties of LED lighting.

LM-80

IESNA standard that establishes the procedure to test the lifespan of LED lighting.

Lumen

Measurement unit for the lighting output of lamps or fixtures.

Lumens per Watt

Lumens Per Watt (LPW) is the light output per unit of energy consumption and it reflects the lighting system's efficacy.

Luminous Flux

Total output emitted by a light source, measured in lumens. The luminous flux describes the total lighting output of a lighting fixture without considering direction.

Lux

Measurement unit for illuminance, or lumens per unit of area. One lux is equivalent to one lumen per square meter.

Photometry

The measurement of light and its properties.

Power Factor (PF)

Ratio of real power to apparent power drawn by lighting fixtures and other electrical devices. The real power is represented by the actual watts consumed, while the apparent power is the multiplication product of voltage and current, measured in volt-amperes.

Reflector

An internal component of many lamps and luminaires. It has a reflective surface and its geometry is specially designed to provide a specific lighting distribution.

Note

1. Please reconfirm Specifications and Dimensions Mentioned in this catalogue, Prior to order due to continuously Improvement in design.

2. M/s Luker Electric Technologies Pvt Ltd, Reserves the Right to make Changes in the designs and data and withdraw the luminaires without any prior notice.

WARRANTY TERMS AND CONDITIONS

The company, Luker Electric Technologies Pvt Ltd offers warranty period to the buyers of its products under conditions set out hereafter. The warranty period applies to the functional defects of the Luker range of products resulting from the defectiveness of the material being used or irregularities in the production process, provided that the product is mounted and used in accordance with the Manufacturer's instructions and requirements mentioned in the catalogue or instruction manuals provided. Kindly note that different products are provided with different warranty period and it is mentioned in the product catalogues or may be confirmed with the company before purchase.

Products, for which the warranty provided is that the manufacturer will repair or replace at its discretion with the products of the same type and, at least, the same quality at its own expense. The company will not cover any losses caused to property or person directly or indirectly with the usage of the Luker range of products. The maximum liability due to malfunction of the product is limited only up to its purchase cost of the product.

The warrantee is invalid and not applicable incase of the conditions further detailed below.

If the product is not used in accordance with the Manufacturer's instructions or the product is used for purposes other than those for which it was designed or the incorrect assembly of the product. If Mechanical damage and faults caused by the Buyer's or third party's incorrect handling of the product or Damage and faults caused by natural disasters (lightning, faults caused by natural disasters (lightning, earthquake, fire, floods etc. or Damage and faults caused by the incorrect electrical voltage (for example, electrical stroke, high voltage surge and similar). If any repairs and interventions in products by unauthorized persons or any modifications of the product done by the customer. Any disputes arising under this warranty clause shall fall only within the jurisdiction of the courts at Ernakulam, Kerala, India.